

Star Trac Pro S™ Treadmill
Star Trac Pro™ Treadmill
Star Trac Pro Elite™ Treadmill

OWNER'S MANUAL



TABLE OF CONTENTS

Introduction	1
Chapter 1: Safety Instructions	2
Vieligheidsinstructies	3
Precautions	4
Mesures de Precaution	5
Sicherheitsvorschriften	6
Istruzioni di Sicurezza	7
Instruções de Segurança	8
Instrucciones de Seguridad	9
Sikkerhedsinstruktioner	10
Chapter 2: Assembly and Setup	11
Unpacking	11
Assembly	11
Chapter 3: Operating Instructions (Pro / Pro Elite)	17
Display Control Panel Features	17
Hints and Tips for Getting Started	18
Quick Start	19
Preset Programs	19
Cooldown Cycle	27
Using the Cooling Fan	27
Using the Weight Scale	27
Heart Rate Monitoring	28
Chapter 4: Operating Instructions (Pro S)	29
Display Control Panel Features	29
Hints and Tips for Getting Started	30
Quick Start	30
Preset Programs	31
Cooldown Cycle	35
Heart Rate Monitoring	35
Chapter 5: Personal Trainer Studio™	36
Personal Trainer Studio™	36
Using Personal Trainer Studio™	36
Maintaining PIN Numbers	36
Managing Custom Programs	37
Chapter 6: Training Information	40
The First Step to a Better Lifestyle	40
Getting Started - Walkers and Runners	40
Climbing the Conditioning Ladder - Suggested Programs	41
Program Variation on the PRO S / PRO / PRO ELITE Treadmill	42
Tips to Stay Motivated	43
Chapter 7: Preventative Maintenance	44
Daily Maintenance	44
Weekly Maintenance	44
Bi-Weekly Maintenance	44
Monthly Maintenance	44
Adjustments	44
Rewax Belt	45
Chapter 8: Engineering and Test	47
Manager Settings	47
Maintenance Settings	48
Calibrate Scale	51
Speed Calibration	52
Elevation Calibration	52
Club Naming	52
CSAFE Company Naming	53
Chapter 9: Troubleshooting	55
Chapter 10: Regulatory Information	56
FCC and Other Domestic / International Regulations	56
International Regulations	56

INTRODUCTION

Welcome to the world of **STAR TRAC**. This Owner's Manual will acquaint you with the assembly, operation and maintenance of your **STAR TRAC PRO S / PRO / PRO ELITE TREADMILL**, so that you may begin reaching your fitness goals.

The **PRO S / PRO / PRO ELITE** Treadmills provide the most comprehensive integration of user needs with the Club's needs in the Club's most used cardio vascular product, the Treadmill. Users will appreciate the multifunctional display of the **Pro series** for its style and utility. With a Walkman rest, reading rack, bottle holder and towel hanger stylishly integrated into the display, it is obvious that the design was generated with the user in mind. Further, the simplicity of these programmable treadmills understates their usability and feature-rich design.

We highly recommend that you read this owner's manual prior to setting up and using your treadmill. The information on the following pages will enable you to begin easily, quickly and safely.

WARNING

Your **STAR TRAC PRO S / PRO / PRO ELITE TREADMILL** is designed for aerobic exercise in a gymnasium or health club environment.

Please check with your physician prior to beginning any exercise program.

Do not push yourself to excess. Stop if you are feeling faint, dizzy, or exhausted. Use common sense when walking or running on treadmill. Please read the owner's manual in its entirety before operating the treadmill.

IMPORTANT SAFETY INSTRUCTIONS

WARNING:

This product will be wired for either 120 VAC nominal power input OR 230 VAC nominal input. It is factory-equipped with a specific electric cord and plug to permit connection to the proper electric circuit. Make sure that the product is connected to a dedicated power line having an outlet with the same configuration as that of the plug. NO adapter should be used with this product. If the product must be reconnected for use on a different type of electric circuit, the reconnection should be made by qualified service personnel.

SAVE THESE INSTRUCTIONS

ATTENTION EQUIPMENT INSTALLERS

Star Trac recommends that treadmills be spaced a minimum of 20.0 inches (0.5 m) apart to allow safe and easy ingress and egress. More importantly, there must be at least 48 inches (1.25 m) of free space behind the treadmills.

As with any motorized equipment, the area where treadmills are located must be free of obstructions and fixtures with sharp edges to prevent injury in the event that a user trips or loses balance and falls.

NOTE

The **STAR TRAC Pro Elite** treadmills are equipped with a system of measuring a user's static weight. By no means is this system to be considered for use in trade, or for medical application

This chapter includes fitness safeguards and precautions for the installation and use of the Pro / Pro S Treadmill. These safety notes are directed to you as the owner of the Star Trac Pro / Pro S Treadmill. Please read this chapter carefully before installing or using your equipment and be sure to train all your members and fitness staff to follow these safety instructions.

Safety instructions are provided in the following languages (in the order shown):

- Dutch
- English
- French
- German
- Italian
- Portuguese
- Spanish
- Swedish

VEILIGHEIDSinSTRUCTIES

WAARSCHUWING

Dit produkt is voor gebruik op een circuit met een nominale waarde van 120 volt en is in de fabriek uitgerust met een speciaal elektrisch snoer en stekker om verbinding met een passend elektrisch circuit toe te staan. Zorg ervoor dat dit produkt verbonden is met een stopcontact dat dezelfde configuratie heeft als de stekker. **GEBRUIK GEEN ADAPTER BIJ DIT PRODUKT.** Als het produkt opnieuw verbonden moet worden met een ander type van elektrisch circuit, dan moet deze verbinding gemaakt worden door gekwalificeerd onderhoudspersoneel.



VOORZICHTIG: NEEM DE STEKKER UIT HET STOPCONTACT VOOR HET RENIGEN OF ONDERHOULD.



VOORZICHTIG: LEES HET INSTRUCTIEHANDBOEK VOORDAT U DE MACHINE BEDIENT.



(INSERT "E") CAUTION: MOVING PARTS, KEEP HANDS AND FEET FROM UNDER THE TREADMILL WHEN OPERATING



STOPPEN (VAN ACTIE)



WISSELSTROOM



AAN

UIT

Deze veiligheidsinstructies zijn aan u gericht als de eigenaar van de **STAR TRAC PRO S / PRO / PRO ELITE-HARDLOOPBAND**. Train uw leden en fitness-personeel om deze veiligheidsinstructies te volgen.

LEES ALLE INSTRUCTIES VOORDAT U DE HARDLOOPBAND GEBRUIKT.

WAARSCHUWING: Om het risico van een elektrische schok te verminderen, dient u de stekker van de hardloopband **ALTIJD** uit het stopcontact te nemen voordat u hem schoonmaakt.

DOE DIT WEL

Stop de bediening van de hardloopband als u zich duizelig voelt of het gevoel heeft dat u flauwvalt.

Weet hoe ver u kunt gaan.

(INSERT "C") Do keep the belt surface clean and dry.

Neem de stekker uit het stopcontact voordat u de band reinigt of welk onderdeel dan ook verwijdert of vervangt. Gebruik dit product alleen voor het doeleinde waarvoor het bestemd is.

(INSERT "B") Do be aware of the location and proper use of the emergency STOP switch.

Verricht regelmatig preventief onderhoud.

Houd het snoer bij verwarmingssystemen vandaan.

Wacht totdat de lopende band stil staat voordat u van de hardloopband stapt.

Houd luchtopeningen vrij van pluizen, haar etc. Bedien de hardloopband nooit met geblokkeerde luchtopeningen.

Schakel de stroom uit bij de contactschakelaar.

DOE DIT NIET

Laat kinderen niet zonder toezicht de hardloopband bedienen.

(INSERT "D") Do not exceed the maximum allowable weight limit (**350 lbs. / 159 kg**) for the treadmill.

Ga de band niet op af terwijl deze loopt.

Niet buiten gebruiken.

(INSERT "A") Do not wear loose or hanging clothing while using the treadmill.

Draai de lopende band niet te strak aan.

Bedien de hardloopband niet als deze een beschadigd snoer of stekker heeft, als hij niet goed werkt of als hij gevallen of beschadigd is. Neem contact op met uw geautoriseerde **STAR TRAC** detailhandelaar of de onderhoudsafdeling van **STAR TRAC** op +1 (714) 669-1660 of bezoek onze website op <http://www.startrac.com> voor een onmiddellijke inspectie of reparatie.

Gebruik de hardloopband niet zonder gym schoenen. Laat nooit objecten in het apparaat vallen en steek geen objecten, handen of voeten in welke opening van het apparaat dan ook of onder het apparaat.

Plaats geen waterflessen of bekers op uw hardloopband tenzij u een houder heeft die speciaal ontworpen is voor hardloopbanden. Gebruik uw hardloopband niet in een omgeving waar spuitbussen worden gebruikt of waar zuurstof wordt toegediend.

Bedien het apparaat niet zonder de motorafscherming of pas het apparaat op geen enkele wijze aan.

PRECAUTIONS



CAUTION: READ THE OWNER'S MANUAL COMPLETELY BEFORE OPERATING THIS TREADMILL



CAUTION: BEFORE CLEANING OR SERVICING, DISCONNECT POWER SUPPLY



CAUTION: MOVING PARTS, KEEP HANDS AND FEET FROM UNDER THE TREADMILL WHEN OPERATING



STOP (OF ACTION)



ALTERNATING CURRENT

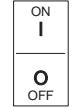

ON

OFF

These safety notes are directed to you as the owner of the **STAR TRAC PRO S / PRO / PRO ELITE TREADMILL**. For safety purposes, please train all your members and fitness staff to follow these safety instructions.

DO

Do encourage your members to discuss their health program or fitness regimen with a health care professional, especially if they have not exercised for several years, are over 35, or have known health conditions.

Do read all instructions in this manual before using your treadmill.

Do use your treadmill only for its intended use, as described in this manual.

Do check to ensure the belt is not moving prior to using the treadmill.

Do keep the belt surface clean and dry.

Do stop operating your treadmill if you feel dizzy, faint or exhausted.

Do exercise slowly until you reach a level of comfort and security.

Do be aware of the location and proper use of the emergency STOP key.

Do perform regular preventive maintenance as suggested in the manual.

Do keep the electrical cord away from sources of excessive heat.

Do keep the treadmill air openings free of lint, hair, etc.

Do unplug your treadmill before doing any maintenance or cleaning.

Do warm up and cool down before and after each workout.

Do set your goals (see Getting Started in Chapter 6).

Do complement your walking, jogging, and running with a nutritious diet.

Do try charting your progress using the feedback from your treadmill.

Do try using the incline feature to burn more calories and strengthen your lower-body muscles.

DO NOT

Do not let children operate your treadmill. Supervise invalids or disabled persons who use your treadmill.

Do not exceed the maximum allowable weight limit (**350 lbs. / 159 kg**) for the treadmill.

Do not leave your treadmill unattended when it is plugged in. Unplug it from the outlet when it is not in use, and before you remove or replace any parts or accessories.

Do not use your treadmill without athletic shoes.

Do not wear loose or hanging clothing while using the treadmill.

Do not step or jump on or off your treadmill if the belt is moving.

Do not use or store your treadmill outdoors or in an enclosed pool environment.

Do not ever drop or insert any object, hands, or feet into any opening, or underneath this equipment.

Do not place water bottles or cups on your treadmill unless you are using the designed holders for the treadmill. Do not use your treadmill where aerosol (spray) products are being used or where oxygen is being administered.

Do not use attachments or parts not recommended by the manufacturer.

Do not run the equipment with the motor shroud removed, or modify the equipment in any way.

Do not overtighten the running belt.

Do not operate your treadmill if it has a damaged cord or plug, if it is not working properly, if it has been dropped or damaged, or if the display shows an error code. Call your dealer or Unisen at (800) 503-1221, or USA 1-714-669-1660 for service.

MESURES DE PRECAUTION



ATTENTION: LISEZ SOIGNEUSEMENT LE MANUEL D'UTILISATION AVANT D'UTILISER CE TAPIS ROULANT



ATTENTION: DÉBRANCHEZ A LA SOURCE AVANT D'EFFCTUER UN ENTRETIEN DU UNE RÉPARATION



ATTENTION: NE PAS GLISSER LAS MAÍNS DU LES PIADS SOUS LE TAPIS ROULANT EN ACTION



ARRÊT (MISE HORS SERVICE)



COURANT ALTERNATIF

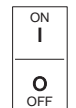

OUVRE

FERME

Ces instructions sont destinées au propriétaire du **TAPIS STAR TRAC PRO S / PRO / PRO ELITE**. Assurez vous que votre personnel et vos adhérents les suivent toujours.

Encouragez vos adhérents à parler de leur programme d'entraînement à un médecin ou un entraîneur, en particulier s'ils n'ont pas eu d'activité sportive pendant plusieurs années, s'ils ont plus de 35 ans ou s'ils ont des kilos superflus.

Lisez le manuel avant faire fonctionner le tapis.

Utilisez le tapis exclusivement aux fins dont il est destiné. N'utilisez pas d'accessoires qui n'ont pas été recommandés par le fabricant.

Attachez toujours vos lacets et vêtements quand vous courez sur le tapis.

(INSERT "C") Do keep the belt surface clean and dry.

Arrêtez si vous êtes pris de vertiges ou épuisé.

Commencez toujours à une vitesse lente.

Respectez les périodes d'échauffement et de récupération.

(INSERT "B") Do be aware of the location and proper use of the emergency STOP switch.

Entrez vos objectifs (voir chapitre 6).

Complétez votre entraînement par un régime alimentaire.

Suivez votre progrès grâce aux informations du tableau de bord.

Essayez d'utiliser l'inclinaison afin de brûler plus de calories et de renforcer les muscles de membres inférieurs.

Effectuez régulièrement l'entretien préventif du tapis.

Mettez les fils électriques à l'abri de chaleur.

Enlevez poussière, cheveux etc. de l'aération.

Ne laissez pas d'enfants non-accompagnés sur le tapis. Une surveillance très stricte est nécessaire si des personnes invalides ou handicapées utilisent le tapis.

(INSERT "D") Do not exceed the maximum allowable weight limit (350 lbs. / 159 kg) for the treadmill.

Ne laissez jamais le tapis sans surveillance s'il est branché. Débranchez le tapis si vous ne l'utilisez pas ou avant de monter ou démonter des pièces.

(INSERT "A") Do not wear loose or hanging clothing while using the treadmill.

Utilisez le tapis uniquement avec des chaussures appropriées.

Ne descendez pas ou ne montez pas sur un tapis qui est en fonction.

N'utilisez ou ne stockez jamais le tapis à l'extérieur ou près d'une piscine.

Ne laissez rien rentrer dans les ouvertures. Ne posez pas vos pieds sous l'appareil.

Ne posez pas de bouteilles ou verres d'eau sur l'appareil sans être équipé avec le () en option.

N'utilisez pas le tapis dans les endroits où des aérosols ou de l'oxygène ont été utilisés.

Débranchez le tapis avant le nettoyage ou le changement de fusibles.

N'enlevez pas de vis, ne modifiez pas l'appareil.

Ne serrez pas trop fort la surface caoutchoutée.

N'utilisez pas cet appareil si les fils ou la fiche sont endommagés, s'il est tombé ou cassé. Appelez votre distributeur pour une révision ou réparation.

SICHERHEITSVORSCHRIFTEN

WARNUNG

Dieses Produkt ist für den Gebrauch an einer passenden Netzsteckdose mit 220 Volt Spannung bestimmt und werkseitig mit einer dafür vorgesehenen Netzleitung und einem Netzstecker ausgerüstet. Stellen Sie sicher, daß das Gerät nur an einem Anschluß mit gleicher Bauart wie der Stecker angeschlossen wird. **VERWENDEN SIE DEINEN ADAPTER FÜR DEN BETRIEB DES PRO / PRO S.** Wenn das Gerät zum Betrieb an einem anderen Stromnetz auf einen anderen Netzstecker umgerüstet werden muß, sollte die Umrüstung durch einen qualifizierten Elektriker durchgeführt werden.



ACHTUNG: GERÄT VOR DEM REINIGEN ODER WARTEN VON DER STROMVERSORGUNG TRENNEN



Diese BEDIENUNG UNTERBRECHEN



ACHTUNG: VOR DER BENUTZUNG SICHERHEITSVORSCHRIFTEN LESEN



WECHSELSTROM



(INSERT "E") CAUTION: MOVING PARTS, KEEP HANDS AND FEET FROM UNDER THE TREADMILL WHEN OPERATING

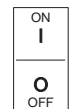

EIN

AUS

Sicherheitshinweise sind an Sie, den Besitzer des Laufbandes **STAR TRAC PRO S / PRO / PRO ELITE**, gerichtet. Bitte weisen Sie Ihre Mitglieder und Ihre Fitneß-Mitarbeiter an, sich an die folgenden Sicherheitsvorschriften zu halten.

LESEN SIE ALLE ANWEISUNGEN VOR DER BENUTZUNG DEL LAUFBANDES.

WARNUNG: Um das Risiko eines elektrischen Schlages zu vermeiden, nehmen Sie den Stecker des Laufbandes vor dem Reinigen **IMMER** aus der Netzsteckdose.

SIE SOLLTEN...

Die Benutzung des Laufbandes beenden, wenn Schwindel oder Benommenheit auftritt.

Au Ihre Grenzen denken.

Das Laufband vor jeglichen Wartungsund Reinigungsarbeiten abschalten.

Das Gerät nur für den vorgesehenen Verwendungszweck benutzen.

(INSERT "C") Do keep the belt surface clean and dry.

(INSERT "B") Do be aware of the location and proper use of the emergency STOP switch.

Regelmäßige vorbeugende Wartungsarbeiten durchführen.

Die elektrischen Leitungen von Wärmequellen fernhalten.

Den Stillstand des Laufriemens abwarten, bevor Sie das Laufband auseinanderbauen.

Die Lüftungsöffnungen frei von Staub, Haaren und Ähnlichem halten.

Das Laufband niemals mit verdeckten Lüftungsschlitzen betreiben.

Die Stromversorgung immer am Netzschalter abschalten.

SIE SOLLTEN NIEMALS...

Kinder das Laufband unbeaufsichtigt benutzen lassen.

(INSERT "D") Do not exceed the maximum allowable weight limit (350 lbs. / 159 kg) for the treadmill.

Schutzvorrichtungen entfernen oder das Gerät umbauen.

(INSERT "A") Do not wear loose or hanging clothing while using the treadmill.

Das Gerät im Freien benutzen.

Den Laufriemen überspannen.

Das Laufband mit beschädigter Netzleitung betreiben, wenn es nicht richtig funktioniert, heruntergefallen ist oder beschädigt wurde. Für sofortige Reparaturunterstützung kontaktieren Sie einen autorisierten Händler oder den Kundendienst von **STAR TRAC** telefonisch unter +1 714 669 1660, bzw. Benutzen Sie unsere Web-Seite unter <http://www.startrac.com>.

Das Laufband ohne die passenden Sportschuhe benutzen.

Gegenstände in eine Öffnung am Gerät hineinfallen lassen.

Gegenstände, Hände oder Füße in eine Öffnung am Gerät stecken oder diese unter das Gerät legen.

Wasserflaschen oder Trinkbecher auf das Laufband stellen, es sei denn, Sie haben ein speziell für diesen Zweck und für dieses Laufband gedachtes Zubehörteil.

Das Laufband in Räumlichkeiten benutzen, in denen Produkte in Aerosoldosen (Sprays) angewandt werden oder in denen Sauerstoff verabreicht wird.

Das Laufband mit abgenommener Motorabdeckung laufen lassen, oder das Gerät auf irgendeine Art und Weise verändern.

ISTRUZIONI DI SICUREZZA

ATTENZIONE

Questo prodotto è da usare su un circuito elettrico con una tensione nominale di 220 volt ed è fornito dalla fabbrica con un cavo elettrico e spina specifici per permettere il collegamento ad un circuito elettrico appropriato. Assicuratevi che il prodotto sia collegato ad una presa che abbia la stessa configurazione della spina. **NESSUN ADATTATORE DEVE ESSERE USATO CON QUESTO PRODOTTO.** Se il prodotto deve essere ricollegato per l'uso su un circuito elettrico diverso, il ricollegamento deve essere effettuato da un elettricista qualificato.



ATTENZIONE: PRIMA DI PULIRE O ESEGUIRE LA MANUTENZIONE, TOGLIETE LA SPINA



ATTENZIONE: PRIMA DI USARE LEGGETE IL MANUALE DELLE ISTRUZIONI



(INSERT "E") CAUTION: MOVING PARTS, KEEP HANDS AND FEET FROM UNDER THE TREADMILL WHEN OPERATING



FERMA IL MOVIMENTO



CORRENTE ALTERNATA

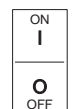

ACCESO

SPENTO

Queste indicazioni sono indirizzate ai proprietari del **TREADMILL STAR TRAC PRO S / PRO / PRO ELITE**. Chiedete a tutti i membri della vostra palestra e al vostro staff di seguire queste istruzioni di sicurezza.

LEGGETE TUTTE LE ISTRUZIONI PRIMA DI USARE IL TREADMILL.

ATTENZIONE: per ridurre il rischio di scossa elettrica, staccate **SEMPRE** la spina della corrente del treadmill prima di pulirlo.

DA FARE

Fermate il treadmill se vi sentite svenire o avete capogiri.

Siate coscienti dei vostri limiti.

(INSERT "C") Do keep the belt surface clean and dry.

Staccate la spina prima di pulire, spostare o cambiare qualsiasi parte del treadmill.

Usate questo prodotto solo per l'uso inteso.

(INSERT "B") Do be aware of the location and proper use of the emergency STOP switch.

Eseguite la manutenzione regolare.

Mantenete la corda elettrica lontana da fonti di calore.

Aspettate fino a quando il nastro è completamente fermo prima di scendere dal treadmill.

Pulite le prese d'aria da polvere, capelli e simili. Non usate mai il treadmill con le prese d'aria bloccate.

Spegnete la macchina tramite l'interruttore.

DA NON FARE

Non permettete a bambini di usare il treadmill senza sorveglianza.

(INSERT "D") Do not exceed the maximum allowable weight limit (**350 lbs. / 159 kg**) for the treadmill.

Non salite o scendete dal treadmill mentre è in funzione.

Non usatelo all'aperto.

(INSERT "A") Do not wear loose or hanging clothing while using the treadmill.

Non tirate troppo il nastro.

Non usate il treadmill se il cavo elettrico o la spina sono danneggiati, se non funziona come dovrebbe o se è caduto o è danneggiato. Contattate il vostro rivenditore autorizzato **STAR TRAC** o l'assistenza clienti dello **STAR TRAC** al numero +1 714 669 1660 o visitate il nostro sito Internet a <http://www.startrac.com>, per esame o riparazione immediata.

Usate il treadmill solo se calzate scarpe da ginnastica.

Non lasciate cadere oggetti e non inserite mani o piedi nelle aperture o al di sotto del treadmill.

Non appoggiate bottiglie d'acqua o bicchieri sul treadmill a meno che non stiate usando un supporto progettato appositamente per il treadmill.

Non usate il treadmill in posti dove sono usati prodotti aerosol (spray) o dove è somministrato dell'ossigeno.

Non accendete il treadmill con il coperchio del motore rimosso, e non modificalo in nessun modo.

INSTRUÇÕES DE SEGURANÇA

ADVERTÊNCIA

Este produto deve ser usado em um circuito com tensão nominal de 220 volts. Ele foi fabricado com um cabo de alimentação e plugue específicos para permitir a sua conexão com um circuito elétrico apropriado. Certifique-se de que o produto esteja conectado a uma tomada com as mesmas configurações do plugue. **NÃO UTILIZE ADAPTADORES PARA ESTE PRODUTO.** Se for necessário reconectar a produto para utilização em um tipo diferente de circuito elétrico, este procedimento deverá ser executado por pessoal qualificado.



ATENÇÃO: ANTES DE LIMPAR OU FAZER MANUTENÇÃO, DESCONECTE O APARELHO DA TOMA DA



ATENÇÃO: LEIA O MANUAL DE INSTRUÇÕES ANTES DE OPERAR A ESTEIRA



(INSERT “E”) CAUTION: MOVING PARTS, KEEP HANDS AND FEET FROM UNDER THE TREADMILL WHEN OPERATING



PARE (A AÇÃO)



CORRENTE ALTERNADA

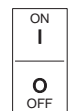

I LIGAR

O DESLIGAR

Estas observações de segurança destinam-se à você, proprietário de **ESTEIRA STAR TRAC PRO S / PRO / PRO ELITE**. Treine todos os membros e funcionários que utilizarão o equipamento para que sigam estas instruções de segurança.

LEIA TODAS AS INSTRUÇÕES ANTES DE USAR SUA ESTEIRA

ADVERTÊNCIA: para reduzir os rescos de choque elétrico, **SEMPRE** desconecte a esteira da tomada antes de limpá-la

Pare de usar a esteira se você se sentir fraco ou com tontura.

(INSERT “C”) Do keep the belt surface clean and dry.

Reconheça seus limites.

Desconecte a esteira da tomada antes de limpá-la ou antes de remover ou substituir qualquer peça.

Utilize este equipamento única e exclusivamente para o seu devido fim.

(INSERT “B”) Do be aware of the location and proper use of the emergency STOP switch.

Faça manutenção preventiva regularmente.

Mantenha o fio afastado de superfícies aquecidas.

Espere até que a esteira esteja completamente parada antes de descer do aparelho.

Mantenha as saídas de ar desobstruídas de fiapos de tecidos, cabelos e outros objetos. Nunca opere a esteira coma as saídas de ar bloqueadas.

Desligue o aparelho com o interruptor de força.

Não permita que crianças operem a esteira sem supervisão de um adulto.

(INSERT “D”) Do not exceed the maximum allowable weight limit (350 lbs. / 159 kg) for the treadmill.

Não suba ou desça da esteira enquanto ela estiver em movimento.

(INSERT “A”) Do not wear loose or hanging clothing while using the treadmill.

Não utilize a esteira ao ar livre.

Não estique demais o tapete da esteira.

Não opere esta esteira se o cabo de alimentação ou o plugue da tomada estiverem danificados, se ela não estiver funcionando perfeitamente ou se tiver sofrido queda ou danos. Procure seu revendedor autorizado **STAR TRAC** ou o departamento de assistência técnica **STAR TRAC** pelo telefone 1 714 669 1660 ou acesse nosso “web site” no endereço <http://www.startrac.com> para fazer uma consulta ou conserto imediato.

Não utilize a esteira sem calçar tênis.

Não deixe cair nem introduza nenhum objeto, as mãos ou pés em nenhuma abertura do equipamento ou debaixo deste.

Não coloque garrafas d’água nem copos na esteira se não estiver utilizando o devido acessório projetado para esse fim. Não utilize a esteira onde estejam sendo usados produtos de aerosol (spray) ou em lugares onde esteja sendo administrado oxigênio. Não opere o equipamento com a tampa do motor removida nem faça nenhuma modificação no equipamento.

INSTRUCCIONES DE SEGURIDAD

ADVERTENCIA

Este producto está preparado para utilizarse en un circuito de 220 voltios y se suministra equipado de fábrica con un cable y un enchufe eléctricos específicos para permitir su conexión a un circuito eléctrico apropiado. Asegúrese de que el producto se conecte a una toma de corriente con la misma configuración que el enchufe. **NO UTILICE NINGÚN ADAPTADOR CON ESTE PRODUCTO.** Si este producto necesita ser modificado eléctricamente para utilizarse en un tipo diferente de circuito eléctrico, dicha modificación debe ser realizada únicamente por el personal de servicio calificado.



ATENCIÓN: DESCONECTE EL SUMINISTRO DE CORRIENTE ANTES DE LIMPIAR O REPARAR



ATENCIÓN: LEA EL MANUAL DE INSTRUCCIONES ANTES DE SU UTILIZACIÓN



(INSERT "E") CAUTION: MOVING PARTS, KEEP HANDS AND FEET FROM UNDER THE TREADMILL WHEN OPERATING



PARAR (EL FUNCIONAMIENTO)



CORRIENTE ALTERNA

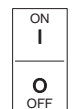

ENCENDIDO

APAGADO

Estas notas sobre seguridad van dirigidas a Vd. Como propietario del **TAPIZ RODANTE STAR TRAC PRO S / PRO / PRO ELITE**. Haga que todos los usuarios y preparadores físicos cumplan estas instrucciones de seguridad.

LEA TODAS LAS INSTRUCCIONES ANTES DE UTILIZAR SU TAPIZ RODANTE.

ADVERTENCIA: Para reducir los riesgos de sufrir una descarga eléctrica, desenchufe **SIEMPRE** el tapiz rodante antes de limpiarlo.

QUÉ HACER

Detenga el tapiz rodante si se nota desfallecido o mareado.

(INSERT "C") Do keep the belt surface clean and dry.

Conozca sus limitaciones.

Desenchufe el tapiz rodante antes de limpiar, quitar o cambiar alguna pieza.

(INSERT "B") Do be aware of the location and proper use of the emergency STOP switch.

Utilice este producto sólo para los usos que está diseñado.

Realice un mantenimiento preventivo de manera regular.

Mantenga el cable separado de fuentes de calor.

Espere a que la cinta móvil haya parado antes de descender del tapiz rodante.

Mantenga las entradas de aire libres de pelusa, pelo y similares. No utilice nunca el tapiz rodante con las entradas de aire bloqueadas.

Desconecte de la corriente por medio del disyuntor.

QUÉ NO HACER

No permita que los niños utilicen el tapiz rodante sin supervisión.

(INSERT "D") Do not exceed the maximum allowable weight limit (**350 lbs. / 159 kg**) for the treadmill.

No suba o baje del tapiz rodante mientras está funcionando.

(INSERT "A") Do not wear loose or hanging clothing while using the treadmill.

No debe utilizarse en exteriores.

No tense demasiado la cinta móvil.

No utilice este tapiz rodante si tiene el cable o el enchufe dañados, si no funciona adecuadamente o si ha sufrido algún golpe o deterioro. Póngase en contacto con su vendedor autorizado de **STAR TRAC**, con el departamento de servicios de **STAR TRAC** llamando al número +1 714 669 1660 o accediendo a nuestra página de la web en <http://www.startrac.com>, para un examen o reparación inmediatos.

No utilice el tapiz rodante sin calzado deportivo.

No deje caer ni introduzca ningún objeto, manos o pies en ninguna abertura del aparato o debajo del mismo.

No deje botellas de agua ni tazas sobre su tapiz rodante excepto si utiliza el accesorio adicional diseñado para este fin. No utilice su tapiz rodante en lugares en los que se están usando productos aerosoles (en spray) o en los que se está administrando oxígeno.

No encienda este aparato con la cubierta del motor retirada, ni lo modifique de ninguna manera.

SIKKERHEDSINSTRUKTIONER

ADVARSEL

Dette produkt er beregnet til brug i forbindelse med et el-net med nominal effekt på 220 volt. Det leveres med særlig ledning og stik fra fabrikken, som kun passer til den korrekte type el-net. Sørg for, at produktet er sat til en stikkontakt, som har samme konfiguration som stikket. **DER MÅ IKKE BRUGES ADAPTER TIL DETTE PRODUKT.** Hvis produktet absolut skal omstilles til en anden slags el-net, skal omstillingen foretages af kvalificeret servicepersonale.



FORSIGTIG: AFBRYD EL-KABLET, FØR DU GØR RENT ELLER SERVICERER.



FORSIGTIG: LÆS INSTRUKTIONSHÅNDBOGEN FØR BRUG



(INSERT "E") CAUTION: MOVING PARTS, KEEP HANDS AND FEET FROM UNDER THE TREADMILL WHEN OPERATING



STOP (AF FUNKTION)



VEKSELSTRØM



TÆND

SLUK

Disse sikkerhedsbemærkninger henvendes til ejeren af STAR TRAC **PRO S / PRO / PRO ELITE**-TRÆDEMØLLEN. Sørg venligst for, at alle medlemmer og alt kondipersonale kender og følger disse sikkerhedsregler.

LÆS ALLE INSTRUKTIONERNE, FØR DU BRUGER DIN TRÆDEMØLLE.

ADVARSEL: For at mindske risikoen for at få elektrisk stød, skal du **ALTID** trække trædemøllens stik ud af kontakten, før du gør den ren.

SKAL

Stig af trædemøllen, hvis du bliver mat i kroppen eller svimmel.

Kend dine begrænsninger.

(INSERT "C") Do keep the belt surface clean and dry.

Træk trædemøllens stik ud af kontakten, før du gør den ren, eller fjerner eller udskifter en del.

Brug kun produktet til det formål, det er beregnet til.

Føretag forebyggende vedligeholdelse med regelmæssige mellemrum.

(INSERT "B") Do be aware of the location and proper use of the emergency STOP switch.

Holdledningen fri af varme anlæg.

Vent til løbebåndet standser, før du stiger af trædemøllen.

Hold ventilationsåbningerne fri for fnug, hår og lignende. Brug aldrig trædemøllen med blokerede luftventilationsåbninger.

Sluk for elektriciteten på afbryderkontakten.

MÅ IKKE

Tillad ikke børn uden opsyn at bruge trædemøllen.

(INSERT "D") Do not exceed the maximum allowable weight limit (**350 lbs. / 159 kg**) for the treadmill.

Stig ikke på eller af trædemøllen, mens den kører.

(INSERT "A") Do not wear loose or hanging clothing while using the treadmill.

Brug ikke trædemøllen udendørs.

Stram ikke løbebåndet for meget.

Brug ikke trædemøllen, hvis ledningen eller stikket er beskadiget, hvis trædemøllen ikke fungerer rigtigt, eller hvis den er faldet ned eller væltet og er blevet beskadiget. Kontakt den autoreserede **STAR TRAC**, forhandler eller serviceafdelingen hos **STAR TRAC** Ring på +1 71 46 69 1660 eller du kan få fat i os på vores web-site: <http://www.star-trac.com> for øjeblikkeligt eftersyn eller reparation.

Brug ikke trædemøllen uden kondisko.

Undgå at tabe eller at stikke genstande, hænder eller fødder ind i en åbning i eller under udstyret.

Stil ikke vandflasker eller kopper på trædemøllen, medmindre du har dertil beregnet tilbehør, som er specielt designet til trædemøllen. Brug ikke trædemøllen på steder, hvor der bruges aerosolprodukter (spray), eller hvor der administreres ilt.

Udstyret må ikke køre uden motorafskærmning, og det er ikke tilladt at ændre udstyret på nogen måde.

UNPACKING

Remove all parts from the shipping crate and verify that the following parts were included in your shipment:

Description	Qty.
Frame Assembly w/ Motor Shroud	1
Top Rail with Display	1
Neck	1
Side Rail w/ STOP Switch	1
Side Rail	1
Button, Plastic**	4
Screw, Button Head Socket Cap, 1/4"-28 UNC x 3/8"*	4
Screw, Socket Head Cap, 5/16"-18 UNC x 1.0"*	4
Bolt, Hex-head, 5/16"-18 UNC x 3.0"**	2
Washer, Flat, 5/16" I.D. x 1.5" O.D.	2
Washer, Flat, 5/16" I.D. x 1.2" O.D.**	6
Washer, Split Lock, 5/16"**	6
Screw, 5/16"-18 x 7.5"**	2
Hex (Allen) key, 1/4"**	1
Hex (Allen) key, 5/32"**	1
Screwdriver, Phillips, #2**	1
Screwdriver (blade-tip), 3/32"**	1
Owner's Manual with Warranty Registration Card	1

*Pre-inserted into frame assembly
 Part of included **STAR TRAC tool kit.

Should any component not be present or if you have any operational questions, please call Star Trac's Service department at (800) 503-1221 or USA 1-714-669-1660. Specifically refer to your treadmill serial number and model number listed below:

Serial No. _____

Model No. _____

NOTE: The following assembly procedure applies to the **PRO S, PRO and PRO ELITE** Treadmills. Illustrations show the **PRO ELITE** Treadmill only.

ASSEMBLY

The following tools are required for assembly: Hex (Allen) Key, 1/4"; Hex (Allen) Key, 5/32"; Screwdriver, Phillips; Wrench, 1/2" (not provided). To assemble your **STAR TRAC PRO S / PRO / PRO ELITE TREADMILL**, just follow these steps.

NOTE: Don't fully tighten bolts and screws until all parts are assembled.

1. Unpacking and Positioning the Frame Assembly

Remove all the packaging material so the treadmill is sitting, ready for assembly, on the shipping crate platform. With a helper, lift the treadmill frame assembly from the shipping crate platform and place it in the location where it will be used. Make sure the unit is placed near a power outlet.

Caution: The motor shroud end of the frame assembly is very heavy. Two people may be needed to lift this end when moving the frame assembly.



Step 1

2. Installing the Neck

Remove the four pre-installed neck mounting screws and washers from the motor shroud end of the frame assembly.

Position the neck in place on the motor shroud end of the frame assembly, and re-install the four screws and washers to secure.

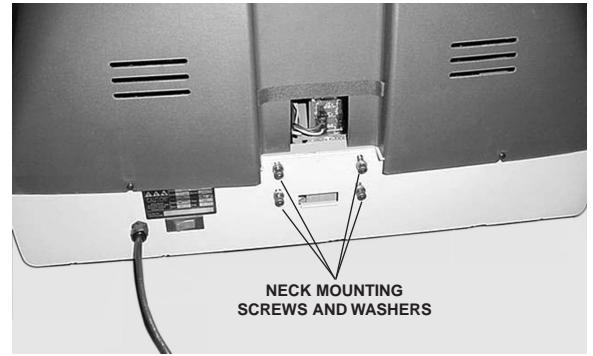

Step 2a



Step 2b

3. Removing the Motor Shroud

Remove the 10-24 screws securing the motor shroud to the frame assembly, and lift the motor shroud off of the frame assembly. Retain the screws for use when re-installing the motor shroud.

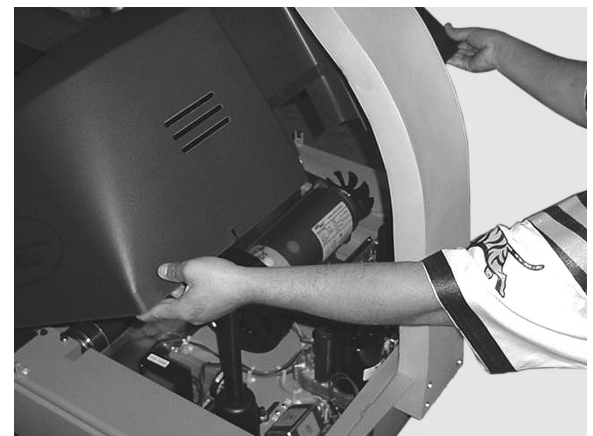

Step 3

4. Installing the Display

Caution: To ensure proper routing of the display cables, it may be necessary to have one person support and position the display while a second person feeds the display cables through the neck assembly.

With two people supporting the display, carefully feed the display cables into the neck. Reposition the display as needed during this step to ensure the display cables do not bunch or kink in the neck. Ensure the display cables feed completely through, and out the bottom, of the neck.

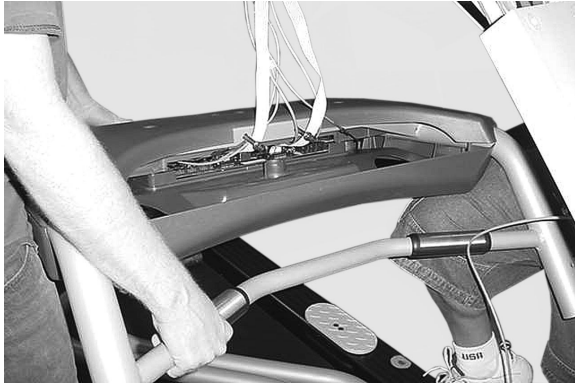

Step 4a



Position the display on the neck, taking care not to pinch the cables between the neck and the display. Once the display is properly positioned, install the two 5/16"-18 bolts to secure the display to the neck.

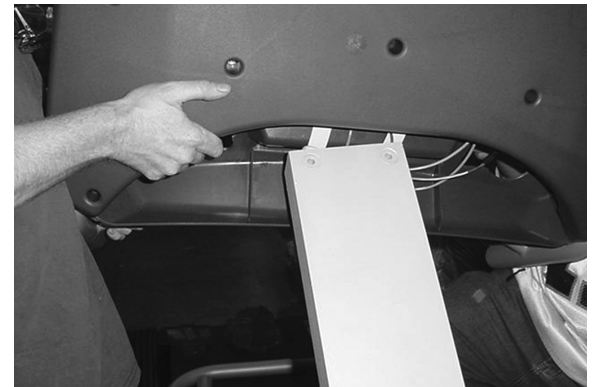

Step 4b



Step 4c



Once the display has been secured in place, route the display cables through the cutout in the neck, and into the motor compartment.



Step 4d

5. Installing the Handrails

Locate the left handrail (the handrail with the STOP switch). Connect the STOP switch cable from the handrail to the display cable extending from the display handrail stub.

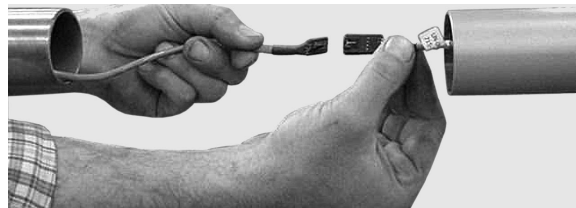

Step 5a

Insert the handrail connecting tube into the display handrail stub, taking care not to pinch the STOP switch cable between the handrail pieces. Make sure the handrail bottoms fully against the display handrail stub.



Step 5b

Rotate the handrail, if necessary, to align the drilled hole in the display handrail stub with the threaded hole in the handrail connecting tube. Secure the handrail to the display handrail stub using two $1/4$ "-28 x $3/8$ " screws.

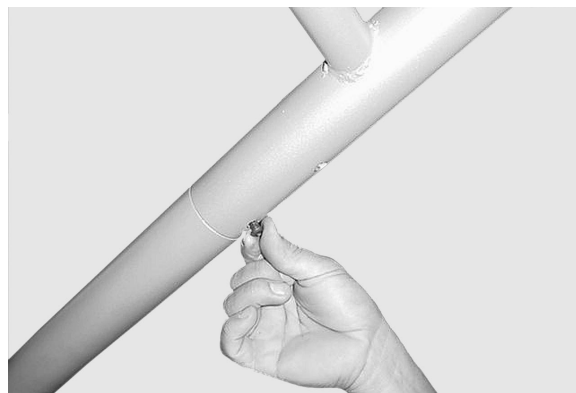

Step 5c

Install the right handrail in a similar manner, as described in steps 5b and 5c, omitting instructions related to the STOP switch cable.



Step 5d

Position the bottom of each handrail over its associated mounting hole in the frame assembly. Insert one 5/16" x 7.5" screw, with a flat washer installed, through the bottom of the frame assembly, and thread into each handrail. Use 9 1/2" wrench to tighten the screws.

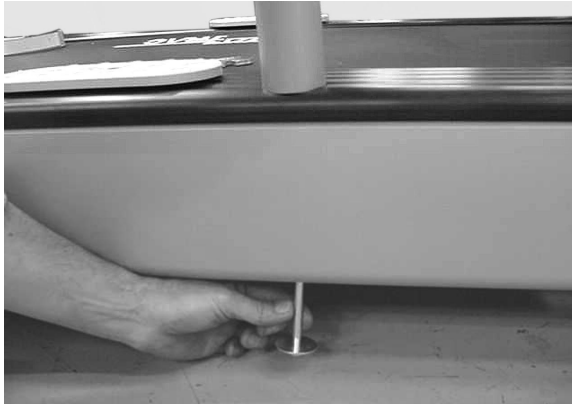

Step 5e

6. Connecting the Display Cables

For units with fans (**PRO / PRO ELITE**), connect the cables tagged 715-3444 and 715-3419 from the display to connectors J3A and P4A, respectively, on the 715-3441 PCB in the motor compartment. The display cable connectors are keyed, and can only be installed in one direction only.

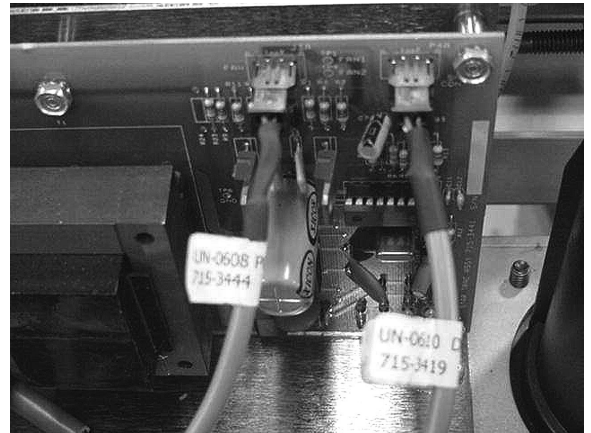

Step 6a

Connect the cable tagged 715-3411 from the display to connector P3 on the 715-3397 (for 110-volt) or 715-3398 (for 220-volt) PCB in the motor compartment. The display cable connector is keyed, and can only be installed in one direction only.

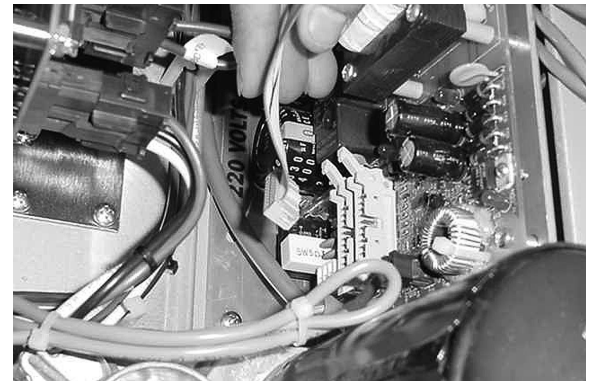

Step 6b

For units with scale system (**PRO ELITE**), connect the cables tagged 715-3418 RIGHT and 715-3418 LEFT from the display to connectors P1 and P2, respectively, on the load cell interface.

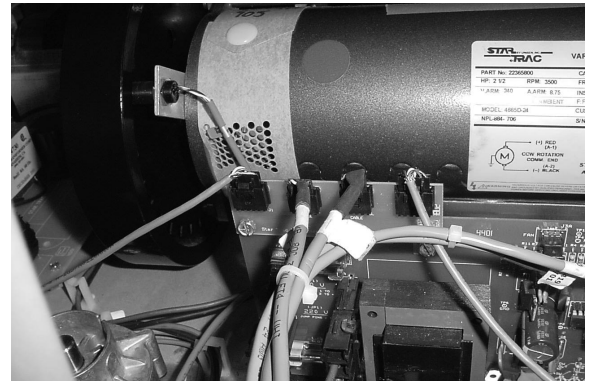

Step 6c

7. Final Assembly

Re-install the shroud over the motor compartment, and secure in place with the previously removed screws. Insert the four plastic buttons into the screw access holes at the bottom of the neck assembly.



Step 7a

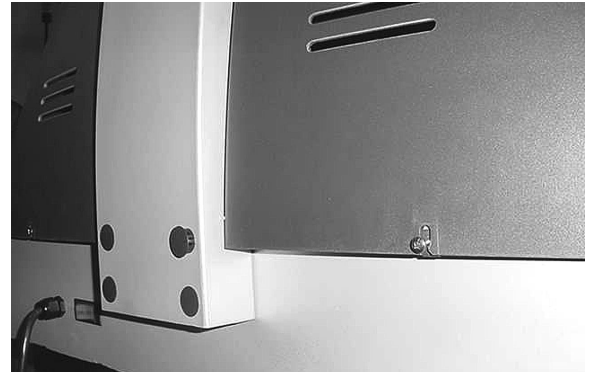

Step 7b



Securely tighten all hardware installed during assembly. If necessary, level your treadmill using the two adjustable feet under the tailroller. Loosen the lock nuts, rotate the feet until the treadmill is stabilized, and retighten the lock nuts.

NOTE: Perform a visual inspection, and test the features and functions of the unit, prior to use. **The weight scale system on your STAR TRAC PRO ELITE Treadmill has undergone a detailed system calibration at our factory and does not require calibration after the unit has been removed from its original factory packaging.**

You have now completed the assembly of your **STAR TRAC PRO S / PRO / PRO ELITE TREADMILL.**

Operating the **STAR TRAC PRO / PRO ELITE TREADMILL** is very easy. Simply step onto the running belt, press QUICK START, and begin walking or running naturally.

Learning the features and incorporating the **STAR TRAC PRO / PRO ELITE TREADMILL** into your members' fitness programs is just as easy. In this chapter, you will learn the display function and how to get the most out of every **STAR TRAC PRO / PRO ELITE TREADMILL** workout.

IMPORTANT: Before operating the treadmill, you must be familiar with the following equipment limitations and safety features.

- **Maximum Weight:** Your STAR TRAC PRO SERIES Treadmill is designed for a maximum user weight of 350 lbs/159 kg. DO NOT exceed the maximum user weight.



- **Emergency Stop:** In case of emergency, press the STOP on the display, or the stop switch on the left-hand side rail.
- **Immobilizing the Running Belt:** To power the unit, set the ON/OFF power breaker to the ON position. To turn the unit off, set the ON/OFF power breaker to the OFF position. When the unit is turned off, movement of the running belt is prevented.

DISPLAY CONTROL PANEL FEATURES

Your **STAR TRAC PRO / PRO ELITE TREADMILL** is equipped to provide you and your users unlimited exercise opportunities. Experiment with its features to find the right combination for your fitness regimen. The Intellitrac™ display provides users with a unique “smart” display that guides the user through the programming and operation of the treadmill. The display keys illuminate only when they are available for use, guiding the user to only those features and functions that are available at any given time. The Display panel shown below provides the operating controls and display elements described in the following paragraphs:

QUICK START

QUICK START Key: Starts your treadmill running belt moving using a default weight of 155 pounds and a time limit of 99 minutes.

START

START Key: Allows for manual operation of the treadmill. The START key also serves as an “Enter” key in programming modes.

STOP

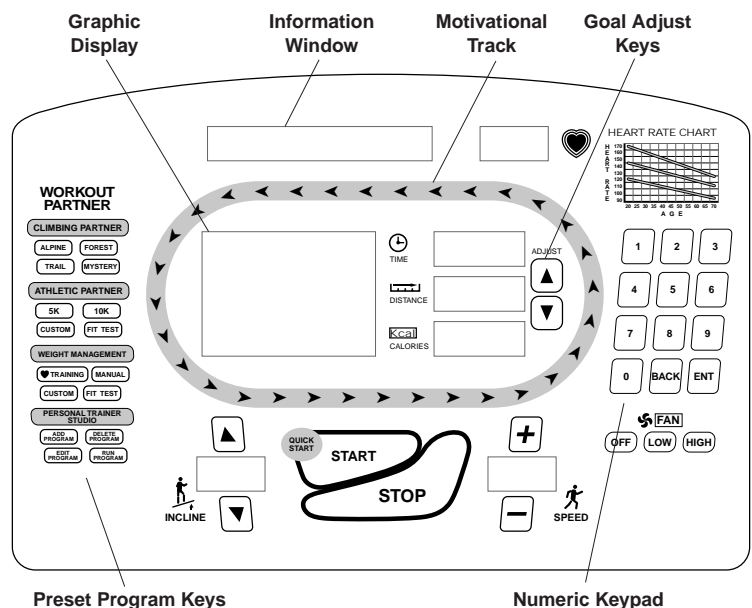

STOP Key: Pauses your treadmill when pressed once. Ends your workout when pressed twice.

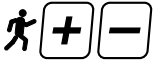

Graphic Display: Traces your progress through each of the programs and allows you to anticipate changes in terrain. Display elements illuminate from left to right across the bottom of the display to indicate your progress through the course. At each step, display elements illuminate in columns to indicate your ascent up the gradient that is in effect.

Motivational Track: Shows your progress counter clockwise around 1/4 mile (400-meter) course, starting from the bottom center.



Speed Keys: Adjust running belt speed in 0.1 miles per hour (mph) or 0.1 kilometers per hour (km/hr) increments. To increase or decrease speed, press the  or  keys, respectively, until the desired speed appears in the Information Window, then, press START. Speed cannot be higher than the established MX SPD parameter (see Chapter 8.) These keys repeat when pressed and held.

Speed Window: Shows the speed at which the user is walking/running, from 0.5 mph (0.8 kph) to 10.0 mph (16.0 kph) for 110-volt units, or 0.5 mph (0.8 kph) to 12.0 mph (19.3 kph) for 220-volt units.



Incline Keys: Adjust treadmill incline in 0.5% increments from 0% through 15% in manual operation. These keys repeat when pressed and held.

Incline Window: Shows the incline that the user is ascending, from 0% (easiest) to 15% (most difficult).



Numeric Keypad: Allow you to enter specific values for program parameters during program setup. The numeric keypad can also be used to adjust treadmill speed while the treadmill is operating.



Time Window: Shows the duration of your workout thus far in minutes and seconds.



Distance Window: Shows the total number of miles or kilometers you have walked or run thus far.



Calorie Window: Shows your aggregate caloric expenditure thus far in your workout.



Goal Adjust Keys : Allow you to increase or decrease your time / distance goal during a workout.



Heart Rate Indicator: Pulsates to indicate your heart rate has been acquired through the use of the heart rate strap or heart rate grips.



Fan Keys: Allow you to control the speed of the personal cooling fan, either OFF, Low or HIGH.

Heart Rate Window: Shows your current heart rate in beats per minute (BPM) while wearing the heart rate strap or grasping the heart rate grips.

WORKOUT PARTNER™ Preset Program Keys: Allow you to access a desired preset workout program.

Information Window: Provides informational messages, prompts during program setup, notification when your workout is complete, and scrolling summarized workout data during and after a workout. Depending on the program completed and treadmill settings as set in Manager or Maintenance Settings mode, workout data may include:

- Time consumed
- Calories expended
- Horizontal distance travelled -miles or kilometers
- Average incline
- Average speed - mph or kph
- Workout time remaining
- Distance remaining - miles or kilometers
- Calories remaining
- Laps completed
- Calories expended per hour
- Minutes per mile/kilometer
- METS
- WATTS
- Heart Rate
- Vertical distance travelled - feet or meters

Every 2000 miles (or 3000 km) the Start-Up Display will also scroll REWAX BELT. See Preventive Maintenance, Chapter 7, for additional information.

HINTS AND TIPS FOR GETTING STARTED

The following hints and tips will assist in training your users to maximize the fitness benefits of your **STAR TRAC PRO / PRO ELITE TREADMILL**.









- Walk or run at a rate that feels comfortable and most natural, yet is sufficiently vigorous to get a good cardio workout.

- **Try different walking or running rhythms.** In manual operation, adjust your pace from low speed to high speed, then back to low. As you become more comfortable with your treadmill, try going faster or using the preset programs.
- **Watch the Graphic Display to anticipate terrain changes.** When you use the preset programs, the display shows changes in terrain as tall or short columns. The display also notifies you of incline changes with a series of beeps and a flashing display element.

QUICK START

Quick Start lets you begin your workout by simply pressing one key. Quick Start uses a default weight of 155 pounds and a time limit of 99 minutes. YOU control the treadmill speed, incline and distance for up to the maximum allowed program time.

To operate the Quick Start program:

1. Stand on the running belt and press the QUICK START key. The running belt slowly accelerates to its minimum speed of 0.5 mph (0.8 kph).
2. You can adjust the incline of the treadmill during the program:
 - You can adjust treadmill incline from 0 to 15%, in 0.5% increments. Press the  key to increase the treadmill incline; press the  key to decrease the treadmill incline.
3. You can adjust the speed of the treadmill during the program:
 - You can specify a desired speed from 0.5 to 10.0 mph (0.8 to 16.0 kph) for 110-volt units or 0.5 to 12.0 mph (0.8 to 19.3 kph) for 220-volt units, using the numeric keypad. Use the ... keys to enter your desired speed, then press the START or ENTER key to accept the entered speed.
 - You can adjust treadmill speed from 0.5 to 10.0 mph (0.8 to 16.0 kph) for 110-volt units or 0.5 to 12.0 mph (0.8 to 19.3 kph) for 220-volt units, in 0.1 mph (or 0.1 kph) increments. Press the  key to increase the treadmill speed; press the  key to decrease the treadmill speed.
4. You can adjust your time goal during the program:
 - You can adjust your time goal from 5 minutes to the maximum allowed program time. Press the ADJUST  key to increase your time goal; press the ADJUST  key to decrease your time goal.
5. You can pause the program during your workout by pressing the STOP key once. The program will pause for a preset period of time (either 30, 45 or 60 seconds, as set in the Manager Settings mode). Press the START key BEFORE the pause timer expires to resume your program. The treadmill returns to its minimum speed when you exit the pause mode.
6. When you have reached your workout goal, the treadmill will enter the Cooldown cycle (see “Cooldown Cycle” for more information). If you wish to exit your program before you have reached your workout goal, press the STOP key twice. The treadmill will slow to a stop. (Press the STOP key once during a Pause to exit the program.)

PRESET PROGRAMS

The PRO / PRO ELITE Treadmill offers 10 preset programs to add variety and challenge to your workout. The preset programs are organized in the WORKOUT PARTNER™ under the headings CLIMBING PARTNER, ATHLETIC PARTNER and WEIGHT MANAGEMENT. Additionally, the PERSONAL TRAINER function lets you work with a Personal Trainer to develop one or more programs customized to your specific needs and/or goals.





CLIMBING PARTNER PROGRAMS

The CLIMBING PARTNER programs were designed for optimal interval training. By taking you through various terrains, your caloric expenditure is maximized and your cardiovascular capacity is improved. When wearing the heart rate strap, or grasping the heart rate contacts, your heart rate is constantly monitored and displayed in the Heart Rate Window to assist you in getting the most efficient workout possible. The FOREST WALK provides an easy workout, while the TRAILBLAZER and ALPINE PASS offer progressively higher levels of intensity. The MYSTERY HIKE offers 250 different terrain configurations to add variety to your workout.



To operate a CLIMBING PARTNER program:

During program setup, you can use the BACK key to return to a previously accepted parameter.

1. Stand on the running belt; press the  key, then press the , ,  or  key, as desired. You are prompted to enter your weight. You may enter your weight manually as described below, or you may use the weight scale to enter your weight (PRO ELITE only; see “Using the Weight Scale” for details).
 - If you do not use the weight scale to enter your weight, the treadmill will display a default weight of 155 pounds (70 kg). You may enter any weight from 0 to 350 pounds (0 to 135 kg).

- You can enter your weight using the numeric keypad. Use the **0**...**9** keys to enter your correct weight.
 - You can press the **▲** or **▼** key, as necessary, to increase or decrease the displayed weight in 1 pound (or 1 kg) increments.
 - When your correct weight has been entered, press the **START** or **ENTER** key to accept the displayed value and advance to the next workout parameter.
2. You are prompted to enter a time goal.
 - The default time goal is 20 minutes. You may enter any time goal from 5 minutes to the maximum allowed program time.
 - You can enter your time goal using the numeric keypad. Use the **0**...**9** keys to enter the desired time goal.
 - You can press the **▲** or **▼** key, as necessary, to increase or decrease your time goal in 1 minute increments.
 - When your desired time goal has been entered, press the **START** or **ENTER** key to accept the displayed value and advance to the next workout parameter.
 3. You are prompted to enter a maximum speed.
 - You may enter any speed from 0.5 to 10.0 mph (0.8 to 16.0 kph) for 110-volt units or 0.5 to 12.0 mph (0.8 to 19.3 kph) for 220-volt units.
 - You can enter the maximum speed using the numeric keypad. Use the **0**...**9** keys to enter the desired maximum speed.
 - You can press the **▲** or **▼** key, as necessary, to increase or decrease the maximum speed in 0.1 unit increments.
 - When the desired maximum speed has been entered, press the **START** or **ENTER** key to accept the displayed value and advance to the next workout parameter.
 4. You are prompted to enter a maximum incline.
 - You may enter any incline from 0.0% to 15.0%
 - You can enter the maximum incline using the numeric keypad. Use the **0**...**9** keys to enter the desired maximum incline.
 - Press the **▲** or **▼** key, as necessary, to increase or decrease the maximum incline in 0.5% increments.
 - When the desired maximum incline has been entered, press the **START** or **ENTER** key to accept the displayed value. You are prompted with a 3 second countdown, then the treadmill begins the program.
 5. You can adjust the incline of the treadmill during the program:

NOTE: Changing the current incline during a program will result in a corresponding change to the maximum incline specified during program setup.

 - You can adjust treadmill incline from 0 to 15%, in 0.5% increments. Press the **▲** key to increase the treadmill incline; press the **▼** key to decrease the treadmill incline.
 6. You can adjust the speed of the treadmill during the program:

NOTE: Changing the current speed during a program will result in a corresponding change to the maximum speed specified during program setup.

 - You can specify a desired speed from 0.5 to 10.0 mph (0.8 to 16.0 kph) for 110-volt units or 0.5 to 12.0 mph (0.8 to 19.3 kph) for 220-volt units, using the numeric keypad. Use the **0**...**9** keys to enter your desired speed, then press the **START** or **ENTER** key to accept the entered speed.
 - You can adjust treadmill speed from 0.5 to 10.0 mph (0.8 to 16.0 kph) for 110-volt units or 0.5 to 12.0 mph (0.8 to 19.3 kph) for 220-volt units, in 0.1 mph (or 0.1 kph) increments. Press the **▲** key to increase the treadmill speed; press the **▼** key to decrease the treadmill speed.
 7. You can adjust your time goal during the program:
 - You can adjust your time goal from 5 minutes to the maximum allowed program time. Press the **▲** key to increase your time goal; press the **▼** key to decrease your time goal.
 8. If desired, you can use the personal cooling fan during your workout (see “Using the Cooling Fan” for details).
 9. You can pause the program during your workout by pressing the **STOP** key once. The program will pause for a preset period of time (either 30, 45 or 60 seconds, as set in the Manager Settings mode). Press the **START** key BEFORE the pause timer expires to resume your program. The treadmill returns to its minimum speed when you exit the pause mode.
 10. If desired, you can jump to another **CLIMBING PARTNER** program if your remaining workout time is greater than 5 minutes.

- To jump to another CLIMBING PARTNER program, press the **CLIMBING PARTNER** key, then press the **FOREST**, **TRAIL**, **ALPINE** or **MYSTERY** key, as desired.
11. When you have reached your workout goal, the treadmill will enter the Cooldown cycle (see “Cooldown Cycle” for more information). If you wish to exit your program before you have reached your workout goal, press the STOP key twice. The treadmill will slow to a stop. (Press the STOP key once during a Pause to exit the program.)

ATHLETIC PARTNER PROGRAMS

The ATHLETIC PARTNER programs were designed for the serious, as well as the recreational runner. You control the speed and incline to add variety and challenge to your workout. The patented Impact Absorption System™ (IAS) Soft Trac™ protects ankles, knees, joints and back while providing a comfortable run. When wearing the heart rate strap, or grasping the heart rate contacts, your heart rate is constantly monitored and displayed in the Heart Rate Window to assist you in getting the most efficient workout possible.

ATHLETIC PARTNER

5K

10K

CUSTOM

FIT TEST

The 5K LAKE LOOP and 10K BAY RUN provide workouts of a preset distance. The CUSTOM INTERVAL lets you create and run a profile based on a desired time or distance goal, with up to 20 segments, utilizing a different speed/incline combination for each segment. The FIT TEST offers a modified version of the Balke and Ware protocol for maximal VO2 treadmill testing.

To operate the 5K LAKE LOOP or 10K BAY RUN programs:

During program setup, you can use the BACK key to return to a previously accepted parameter.

- Stand on the running belt; press the **ATHLETIC PARTNER** key, then press the **5K** or **10K** key, as desired. You are prompted to enter your weight. You may enter your weight manually as described below, or you may use the weight scale to enter your weight (**PRO ELITE only**; see “Using the Weight Scale” for details).
 - If you do not use the weight scale to enter your weight, the treadmill will display a default weight of 155 pounds (70 kg). You may enter any weight from 0 to 350 pounds (0 to 135 kg).
 - You can enter your weight using the numeric keypad. Use the **0**...**9** keys to enter your correct weight.
 - You can press the **▲** or **▼** key, as necessary, to increase or decrease the displayed weight in 1 pound (or 1 kg) increments.
 - When your correct weight has been entered, press the START or ENTER key to accept the displayed value. You are prompted with a 3 second countdown, then the treadmill begins the program.
- You can adjust the incline of the treadmill during the program:
 - You can adjust treadmill incline from 0 to 15%, in 0.5% increments. Press the **▲** key to increase the treadmill incline; press the **▼** key to decrease the treadmill incline.
- You can adjust the speed of the treadmill during the program:
 - You can specify a desired speed from 0.5 to 10.0 mph (0.8 to 16.0 kph) for 110-volt units or 0.5 to 12.0 mph (0.8 to 19.3 kph) for 220-volt units, using the numeric keypad. Use the **0**...**9** keys to enter your desired speed, then press the START or ENTER key to accept the entered speed.
 - You can adjust treadmill speed from 0.5 to 10.0 mph (0.8 to 16.0 kph) for 110-volt units or 0.5 to 12.0 mph (0.8 to 19.3 kph) for 220-volt units, in 0.1 mph (or 0.1 kph) increments. Press the **▲** key to increase the treadmill speed; press the **▼** key to decrease the treadmill speed.
- If desired, you can use the personal cooling fan during your workout (see “Using the Cooling Fan” for details).
- You can pause the program during your workout by pressing the STOP key once. The program will pause for a preset period of time (either 30, 45 or 60 seconds, as set in the Manager Settings mode). Press the START key BEFORE the pause timer expires to resume your program. The treadmill returns to its minimum speed when you exit the pause mode.
- If desired, you can jump to another ATHLETIC PARTNER program if your remaining workout time is greater than 5 minutes.
 - To jump to another ATHLETIC PARTNER program, press the **ATHLETIC PARTNER** key, then press the **5K** or **10K** key, as desired.
- When you have reached your workout goal, the treadmill will enter the Cooldown cycle (see “Cooldown Cycle” for more information). If you wish to exit your program before you have reached your workout goal, press the STOP key twice. The treadmill will slow to a stop. (Press the STOP key once during a Pause to exit the program.)

To operate the CUSTOM INTERVAL program:

During program setup, you can use the BACK key to return to a previously accepted parameter. When entering program parameters, use the **0**...**9** keys to enter the desired value, or use the **▲**/**▼** keys to scroll to the desired value.

1. Press the **ATHLETIC PARTNER** key, then press the **CUSTOM** key. You will be prompted to select a “goal” type, either “Time Goal” or “Distance Goal”.

Press the **1** key to select “Time Goal”; press the **2** key to select “Distance Goal”. The Information Window will display a prompt to enter a time goal, or distance goal, as appropriate:

Time Goal - The default time goal is 20 minutes. You may enter any time goal from 5 to 99 minutes.

Distance Goal - The default distance goal is 5 miles (English units) or 5 kilometers (metric units). You may enter any distance goal from 5 miles (5 kilometers) to 19.80 miles (31.86 kilometers).
2. When the desired goal value has been entered, press the **START** or **ENTER** key to accept the current value. You are prompted to enter your weight. You may enter your weight manually as described below, or you may use the weight scale to enter your weight (**PRO ELITE only**; see “Using the Weight Scale” for details).
 - If you do not use the weight scale to enter your weight, the treadmill will display a default weight of 155 pounds (70 kg). You may enter any weight from 0 to 350 pounds (0 to 135 kg).
 - You can enter your weight using the numeric keypad. Use the **0**...**9** keys to enter your correct weight.
 - You can press the **▲** or **▼** key, as necessary, to increase or decrease the displayed weight in 1 pound (or 1 kg) increments.
 - When your correct weight has been entered, press the **▲** key to accept the displayed value and proceed to the next parameter.
3. The Information Window displays a prompt to enter a time goal or distance goal, as appropriate, for the first segment of the program:

Time Goal - The default segment time goal is 4 minutes. You may enter any time goal from 1 minute to the remaining goal time.

Distance Goal - The default distance goal is 1 mile (English units) or 1 kilometer (metric units). You may enter any segment distance goal from 0.10 miles (0.10 kilometers) to the remaining goal distance.
4. When the desired segment goal value has been entered, press the **START** or **ENTER** key to accept the displayed value and proceed to the next parameter.
5. The Information Window displays a prompt to enter a speed for the first segment of the program.
 - You may enter any speed from 0.5 to 10.0 mph (0.8 to 16.0 kph) for 110-volt units or 0.5 to 12.0 mph (0.8 to 19.3 kph) for 220-volt units, in increments of 0.1 units.
6. When the desired segment speed value has been entered, press the **START** or **ENTER** key to accept the displayed value and proceed to the next parameter.
7. The Information Window displays a prompt to enter an incline for the first segment of the program.
 - You may enter any incline from 0.0 to 15.0%, in increments of 0.5%.
8. When the desired segment incline value has been entered, press the **START** or **ENTER** key to accept the displayed value and proceed to the next segment.
9. The Information Window will display prompts for additional program segments. Continue to enter the desired goal (time or distance, as appropriate), speed and incline until values for all segments of the program have been entered. The system will continue to prompt for segment values until one of the following conditions is met:
 - The total number of segments equals 20.
 - The combined value of the segment goals is equal to the total goal.
10. When values for the final segment have been entered, you are prompted with a 3 second countdown, then the treadmill begins the program.
11. You can adjust the incline of the treadmill during the program:
 - You can adjust treadmill incline from 0 to 15%, in 0.5% increments. Press the **▲** key to increase the treadmill incline; press the **▼** key to decrease the treadmill incline.
12. You can adjust the speed of the treadmill during the program:
 - You can specify a desired speed from 0.5 to 10.0 mph (0.8 to 16.0 kph) for 110-volt units or 0.5 to 12.0 mph (0.8 to 19.3 kph) for 220-volt units, using the numeric keypad. Use the **0**...**9** keys to enter your desired speed, then press the **START** or **ENTER** key to accept the entered speed.

- You can adjust treadmill speed from 0.5 to 10.0 mph (0.8 to 16.0 kph) for 110-volt units or 0.5 to 12.0 mph (0.8 to 19.3 kph) for 220-volt units, in 0.1 mph (or 0.1 kph) increments. Press the **▲+** key to increase the treadmill speed; press the **▲-** key to decrease the treadmill speed.
13. You can adjust your time goal during the program:
 - You can adjust your time goal from 5 minutes to the maximum allowed program time. Press the ADJUST **▲** key to increase your time goal; press the ADJUST **▼** key to decrease your time goal.
 14. If desired, you can use the personal cooling fan during your workout (see “Using the Cooling Fan” for details).
 15. You can pause the program during your workout by pressing the STOP key once. The program will pause for a preset period of time (either 30, 45 or 60 seconds, as set in the Manager Settings mode). Press the START key BEFORE the pause timer expires to resume your program. The treadmill returns to its minimum speed when you exit the pause mode.
 16. When you have reached your workout goal, the treadmill will enter the Cooldown cycle (see “Cooldown Cycle” for more information). If you wish to exit your program before you have reached your workout goal, press the STOP key twice. The treadmill will slow to a stop. (Press the STOP key once during a Pause to exit the program.)

To operate the FIT TEST program:

The Fit Test is a modified version of the Balke and Ware protocol for maximal VO₂ treadmill testing. The Fit Test requires 12 minutes to complete. During the Fit Test, treadmill speed remains at a constant 3.4 mph. Treadmill incline is set at 0% during the first minute, increases to 2% during the second minute, and increases by 1% per minute for the remainder of the test. Your heart rate results are compared with charted data for your corresponding age and gender. Test results are given on a scale of 1 to 10, and include your calculated VO₂ max. VO₂ max is a physiological measurement of a bodies ability to absorb oxygen and has specific correlation to your fitness level.

NOTE: You must wear the heart rate strap during the FIT TEST to monitor your heart rate.

During program setup, you can use the BACK key to return to a previously accepted parameter.

1. Stand on the running belt; press the **ATHLETIC PARTNER** key, then press the **FIT TEST** key. You are prompted to enter your weight. You may enter your weight manually as described below, or you may use the weight scale to enter your weight (**PRO ELITE only**; see “Using the Weight Scale” for details).
 - If you do not use the weight scale to enter your weight, the treadmill will display a default weight of 155 pounds (70 kg). You may enter any weight from 0 to 350 pounds (0 to 135 kg).
 - You can enter your weight using the numeric keypad. Use the **0...9** keys to enter your correct weight.
 - You can press the **▲+** or **▲-** key, as necessary, to increase or decrease the displayed weight in 1 pound (or 1 kg) increments.
 - When your correct weight has been entered, press the START or ENTER key to accept the displayed value and advance to the next parameter.
2. You are prompted to enter your age.
 - You may enter any age from 1 to 99 years.
 - You can enter your age using the numeric keypad. Use the **0...9** keys to enter the desired age.
 - You can press the **▲+** or **▲-** key, as necessary, to increase or decrease your age in 1 year increments.
 - When your correct age has been entered, press the START or ENTER key to accept the displayed value and advance to the next parameter.
3. You are prompted to enter your gender.
 - Press the **▲+** or **▲-** key, as necessary, until the appropriate gender is displayed.
 - When your correct gender has been entered, press the START or ENTER key to accept the displayed value. You are prompted with a 3 second countdown, then the treadmill begins the program.
4. The FIT TEST runs for 12 minutes. During the test, the treadmill speed is set at 3.4 mph. The treadmill incline begins at 0% for the first minute, increases to 2% for the second minute, and increases by 1% thereafter for each remaining minute to a maximum incline of 12% during the final minute of the test.

During the test, you MAY NOT adjust treadmill speed or incline, and you MAY NOT pause the program. If your heart rate exceeds 150 BPM for more than one minute, the test will terminate automatically.
5. If desired, you can use the personal cooling fan during the FIT TEST (see “Using the Cooling Fan” for details).
6. When you have reached your workout goal, the treadmill will enter the Cooldown cycle (see “Cooldown Cycle” for more information). If you wish to exit your program before you have reached your workout goal, press the STOP key twice. The treadmill will slow to a stop. (Press the STOP key once during a Pause to exit the program.)

WEIGHT MANAGEMENT PROGRAMS

The WEIGHT MANAGEMENT programs include the CARDIO TRAINING (Dynamic Heart Rate Control), MANUAL, CUSTOM INTERVAL and FIT TEST programs. When using the CARDIO TRAINING (Dynamic Heart Rate Control) program, use of the heart rate strap (rather than the heart rate grips) is recommended.

WEIGHT MANAGEMENT

TRAINING MANUAL

CUSTOM FIT TEST

To operate the Custom Interval and Fit Test programs:

- Stand on the running belt. Press the **WEIGHT MANAGEMENT** key, press the **CUSTOM** or **FIT TEST** key, as desired, then follow the appropriate procedures provided under “Athletic Partner Programs”.

To operate the Heart Rate Training (Dynamic Heart Rate Control) program:

■ Program Definition

This heart rate feature is designed to gradually elevate your heart rate to the upper end of your selected training range, then gradually decrease your heart rate to the lower end of your selected training range using speed and incline. During the workout, this cycle will repeat several times, creating an interval training effect that is customized to the user's desired heart rate training range.

During program setup, there must be at least an 18 BPM difference between the lower heart rate limit and upper heart rate limit to ensure an interval workout.

To calculate your training zone, use the following formulas:
(theoretical max HR = 220 - Age)

Heart Rate Training Range Upper Level

$$\frac{\text{Your Theoretical Max}}{\text{Your Theoretical Max}} \times 0.75 = \frac{\text{Training Range Upper Limit}}{\text{Training Range Upper Limit}}$$

Heart Rate Training Range Lower Level

$$\frac{\text{Your Theoretical Max}}{\text{Your Theoretical Max}} \times 0.60 = \frac{\text{Training Range Lower Limit}}{\text{Training Range Lower Limit}}$$

■ Benefits of Heart Rate Intervals

By including interval exercise in your regular aerobic program, greater effects are noticed. Your heart and muscles will adapt to the increases in demand by utilizing stored calories for energy more effectively. Dynamic Heart Rate Control may potentially result in more calories expended. It will strengthen the heart, provide stress relief and variety to a workout. This program is more effective in training the body to remove excess lactic acid from the muscles.

■ How to Use Dynamic Heart Rate Control

NOTE: For best results, use a heart rate strap. If user is wearing a heart rate strap, the machine will automatically use the data from the heart rate strap. Contact heart rate grips may not give an accurate heart rate when exercising over 4 mph.

During program setup, you can use the BACK key to return to a previously accepted parameter.

1. Stand on the running belt; press the **WEIGHT MANAGEMENT** key, then press the **TRAINING** key. The Information Window displays the message “DYNAMIC HR CONTROL”. Press the START or ENTER key to continue.
2. The Information Window displays the message “INTERVAL PROGRAM VARIES SPEED AND INCLINE TO ALTER YOUR HEART RATE BETWEEN LIMITS, SELECT UPPER AND LOWER HEART RATE LIMITS”. Press the START or ENTER key to continue.
3. You are prompted to enter your weight. You may enter your weight manually as described below, or you may use the weight scale to enter your weight (**PRO ELITE only**; see “Using the Weight Scale” for details).
 - If you do not use the weight scale to enter your weight, the treadmill will display a default weight of 155 pounds (70 kg). You may enter any weight from 0 to 350 pounds (0 to 135 kg).
 - You can enter your weight using the numeric keypad. Use the **0**...**9** keys to enter your correct weight.
 - You can press the **▲+** or **▼-** key, as necessary, to increase or decrease the displayed weight in 1 pound (or 1 kg) increments.
 - When your correct weight has been entered, press the START or ENTER key to accept the displayed value and advance to the next workout parameter.
4. You are prompted to enter your age.
 - You may enter any age from 1 to 99 years.
 - You can enter your age using the numeric keypad. Use the **0**...**9** keys to enter the desired age.
 - You can press the **▲+** or **▼-** key, as necessary, to increase or decrease your age in 1 year increments.
 - When your correct age has been entered, press the START or ENTER key to accept the displayed value and advance to the next parameter.
5. You are prompted to enter your upper heart rate limit.
 - The treadmill displays a default upper heart rate limit based on 75% of the maximum heart rate for your age.

- You can enter a new upper heart rate limit using the numeric keypad. Use the **0**...**9** keys to enter the desired upper heart rate limit.
 - You can use the **▲** or **▼** key, as necessary, to increase or decrease the displayed upper heart rate limit in 1 BPM increments.
 - When the desired upper heart rate limit has been entered, press the **START** or **ENTER** key to accept the displayed value and advance to the next parameter.
6. You are prompted to enter your lower heart rate limit.
- The treadmill displays a default lower heart rate limit based on 60% of the maximum heart rate for your age.
 - You can enter a new lower heart rate limit using the numeric keypad. Use the **0**...**9** keys to enter the desired lower heart rate limit.
 - You can use the **▲** or **▼** key, as necessary, to increase or decrease the displayed lower heart rate limit in 1 BPM increments.
 - When the desired lower heart rate limit has been entered, press the **START** or **ENTER** key to accept the displayed value and advance to the next parameter.
7. You are prompted to enter a maximum speed.
- You may enter any speed from 0.5 to 10.0 mph (0.8 to 16.0 kph) for 110-volt units or 0.5 to 12.0 mph (0.8 to 19.3 kph) for 220-volt units.
 - You can enter the maximum speed using the numeric keypad. Use the **0**...**9** keys to enter the desired maximum speed.
 - You can press the **▲** or **▼** key, as necessary, to increase or decrease the maximum speed in 0.1 unit increments.
 - When the desired maximum speed has been entered, press the **START** or **ENTER** key to accept the displayed value and advance to the next workout parameter.
8. You are prompted to select a workout goal.
- Use the **0**...**9** keys to select a workout goal: press **1** for time goal, **2** for distance goal or **3** for calories goal.
 - When the desired goal has been selected, press the **START** or **ENTER** key to accept the displayed value. You are prompted with a 3 second countdown, then the treadmill begins the program.

■ **During the Workout**

1. During the heart rate controlled workout, the treadmill will respond every 20 seconds to your heart rate. The treadmill uses your heart rate to adjust the intensity of the workout. The treadmill will adjust speed and (if necessary) incline to elevate your heart rate to the specified upper limit, then it will gradually decrease incline and (if necessary) speed to lower your heart rate to the specified lower limit. A typical 20 minute workout may repeat this pattern 3 to 5 times.
2. The program will display various motivational and informative messages throughout the workout. After the workout is complete, the program will scroll the summary workout information.
3. If, for any reason, the treadmill does not detect your heart rate signal, the treadmill will gradually decrease the workout intensity. After the heart rate signal is re-acquired the interval training program will resume.

To operate the Manual Program:

During program setup, you can use the **BACK** key to return to a previously accepted parameter.

1. Stand on the running belt; press the **WEIGHT MANAGEMENT** key, then press the **MANUAL** key. You are prompted to enter your weight. You may enter your weight manually as described below, or you may use the weight scale to enter your weight (**PRO ELITE only**; see “Using the Weight Scale” for details).
 - If you do not use the weight scale to enter your weight, the treadmill will display a default weight of 155 pounds (70 kg). You may enter any weight from 0 to 350 pounds (0 to 135 kg).
 - You can enter your weight using the numeric keypad. Use the **0**...**9** keys to enter your correct weight.
 - You can press the **▲** or **▼** key, as necessary, to increase or decrease the displayed weight in 1 pound (or 1 kg) increments.
 - When your correct weight has been entered, press the **START** or **ENTER** key to accept the displayed value and advance to the next workout parameter.
2. You are prompted to enter a time goal.
 - The default time goal is 20 minutes. You may enter any time goal from 5 minutes to the maximum allowed program time.
 - You can enter your time goal using the numeric keypad. Use the **0**...**9** keys to enter the desired time goal.

- You can press the or key, as necessary, to increase or decrease your time goal in 1 minute increments.
 - When your desired time goal has been entered, press the START or ENTER key to accept the displayed value. You are prompted with a 3 second countdown, then the treadmill begins the program.
3. You can adjust the incline of the treadmill during the program:
 - You can adjust treadmill incline from 0 to 15%, in 0.5% increments. Press the key to increase the treadmill incline; press the key to decrease the treadmill incline.
 4. You can adjust the speed of the treadmill during the program:
 - You can specify a desired speed from 0.5 to 10.0 mph (0.8 to 16.0 kph) for 110-volt units or 0.5 to 12.0 mph (0.8 to 19.3 kph) for 220-volt units, using the numeric keypad. Use the ... keys to enter your desired speed, then press the START or ENTER key to accept the entered speed.
 - You can adjust treadmill speed from 0.5 to 10.0 mph (0.8 to 16.0 kph) for 110-volt units or 0.5 to 12.0 mph (0.8 to 19.3 kph) for 220-volt units, in 0.1 mph (or 0.1 kph) increments. Press the key to increase the treadmill speed; press the key to decrease the treadmill speed.
 5. You can adjust your time goal during the program:
 - You can adjust your time goal from 5 minutes to the maximum allowed program time. Press the ADJUST key to increase your time goal; press the ADJUST key to decrease your time goal.
 6. You can pause the program during your workout by pressing the STOP key once. The program will pause for a preset period of time (either 30, 45 or 60 seconds, as set in the Manager Settings mode). Press the START key BEFORE the pause timer expires to resume your program. The treadmill returns to its minimum speed when you exit the pause mode.
 7. When you have reached your workout goal, the treadmill will enter the Cooldown cycle (see “Cooldown Cycle” for more information). If you wish to exit your program before you have reached your workout goal, press the STOP key twice. The treadmill will slow to a stop. (Press the STOP key once during a Pause to exit the program.)

PERSONAL TRAINER STUDIO™

The PERSONAL TRAINER STUDIO™ lets you work with a Personal Trainer to develop one or more programs customized to your specific needs and/or goals.

NOTE: To add, edit or delete a program, refer to Chapter 5.

To operate a Personal Trainer Studio™ program:

During program setup, you can use the BACK key to return to a previously accepted parameter. When entering program parameters, use the ... keys to enter the desired value or use the / keys to scroll to the desired value.

1. Press the key; you will be prompted to enter a PIN code.
 - Use the ... keys to enter the appropriate PIN code, then press the START or ENTER key.
 - If you do not know the appropriate PIN code, have your trainer enter it for you.
2. Press the key to enter the “Run Program” function.
3. Press the desired ... key to select the program you wish to run.
4. Stand on the running belt and press the START key. You are prompted to enter your weight. You may enter your weight manually as described below, or you may use the weight scale to enter your weight (**PRO ELITE only**; see “Using the Weight Scale” for details).
 - If you do not use the weight scale to enter your weight, the treadmill will display a default weight of 155 pounds (70 kg). You may enter any weight from 0 to 350 pounds (0 to 135 kg).
 - You can enter your weight using the numeric keypad. Use the ... keys to enter your correct weight.
 - You can press the or key, as necessary, to increase or decrease the displayed weight in 1 pound (or 1 kg) increments.
 - When your correct weight has been entered, press the START or ENTER key to accept the displayed value. You are prompted with a 3 second countdown, then the treadmill begins the program.
5. You can adjust the incline of the treadmill during the program:
 - You can adjust treadmill incline from 0 to 15%, in 0.5% increments. Press the key to increase the treadmill incline; press the key to decrease the treadmill incline.

6. You can adjust the speed of the treadmill during the program:
 - You can specify a desired speed from 0.5 to 10.0 mph (0.8 to 16.0 kph) for 110-volt units or 0.5 to 12.0 mph (0.8 to 19.3 kph) for 220-volt units, using the numeric keypad. Use the **0**...**9** keys to enter your desired speed, then press the **START** or **ENTER** key to accept the entered speed.
 - You can adjust treadmill speed from 0.5 to 10.0 mph (0.8 to 16.0 kph) for 110-volt units or 0.5 to 12.0 mph (0.8 to 19.3 kph) for 220-volt units, in 0.1 mph (or 0.1 kph) increments. Press the **▲** key to increase the treadmill speed; press the **▼** key to decrease the treadmill speed.
7. You can adjust your time goal during the program:
 - You can adjust your time goal from 5 minutes to the maximum allowed program time. Press the **▲** key to increase your time goal; press the **▼** key to decrease your time goal.
8. You can pause the program during your workout by pressing the **STOP** key once. The program will pause for a preset period of time (either 30, 45 or 60 seconds, as set in the Manager Settings mode). Press the **START** key BEFORE the pause timer expires to resume your program. The treadmill returns to its minimum speed when you exit the pause mode.
9. When you have reached your workout goal, the treadmill will enter the Cooldown cycle (see “Cooldown Cycle” for more information). If you wish to exit your program before you have reached your workout goal, press the **STOP** key twice. The treadmill will slow to a stop. (Press the **STOP** key once during a Pause to exit the program.)

COOLDOWN CYCLE

Once you have completed your workout program, the treadmill enters a 2-minute cooldown cycle.

To operate the treadmill during Cooldown:

1. You can adjust the incline of the treadmill during the program:
 - You can adjust treadmill incline from 0 to 15%, in 0.5% increments. Press the **▲** key to increase the treadmill incline; press the **▼** key to decrease the treadmill incline.
2. You can adjust the speed of the treadmill during the program:
 - You can specify a desired speed from 0.5 to 10.0 mph (0.8 to 16.0 kph) for 110-volt units or 0.5 to 12.0 mph (0.8 to 19.3 kph) for 220-volt units, using the numeric keypad. Use the **0**...**9** keys to enter your desired speed, then press the **START** or **ENTER** key to accept the entered speed.
 - You can adjust treadmill speed from 0.5 to 10.0 mph (0.8 to 16.0 kph) for 110-volt units or 0.5 to 12.0 mph (0.8 to 19.3 kph) for 220-volt units, in 0.1 mph (or 0.1 kph) increments. Press the **▲** key to increase the treadmill speed; press the **▼** key to decrease the treadmill speed.
3. When the cooldown cycle ends, the treadmill will slow to a stop. If you wish to exit the cooldown cycle before it ends automatically, press the **STOP** key. The treadmill will slow to a stop.

USING THE COOLING FAN

The PRO Treadmill is equipped with a built-in cooling fan to increase your comfort during a workout. You can control the fan speed during your workout.

To operate the cooling fan:

- Press the **FAN HIGH** key to set the fan speed to “high”.
- Press the **FAN LOW** key to set the fan speed to “low”.
- Press the **FAN OFF** key to turn the cooling fan off.
- The fan will remain at the set speed if you pause your program. The fan will turn off automatically if you exit your workout, or when you complete your program.

If the cooling fan is not available for use, the Information Window displays an advisory message when you press the Fan Low or Fan High keys.

USING THE WEIGHT SCALE

The PRO **ELITE** Treadmill is equipped with a built-in weight scale to help you obtain an accurate weight during program setup. Since much of the workout summary data is based on your entered weight, it is important that this parameter is accurate.

NOTE: The weight scale can be used while the treadmill is idle, or during program setup. The weight scale cannot be used while the treadmill is running, or in Pause mode.

To use the weight scale:

- Stand on the weight scale within 10 seconds of being prompted during program setup.
- Wait for the weight scale to acquire your weight (this may take up to 10 seconds).
- When your weight is acquired, it is displayed in the Information Window. During program setup, you can modify the acquired weight if necessary. Press the **▲+** or **▼-** key, as necessary, to increase or decrease the acquired weight in 1 pound (or 1 kg) increments.

When your correct weight has been entered during program setup, press the **START** or **ENTER** key to accept the displayed value.

If you do not step on the weight scale within 10 seconds of being prompted, or if the weight scale is unable to acquire your weight, the treadmill will display a default weight of 155 pounds (70 kg). You will need to manually enter your correct weight.

If the weight scale is not available for use, the Information Window displays an advisory message during program setup. You will need to manually enter your correct weight.

HEART RATE MONITORING



Heart rate monitoring allows you to determine if your treadmill workout is too challenging or not challenging enough. Monitoring heart rate is easy with the **STAR TRAC PRO / PRO ELITE TREADMILL**, which provides both a heart rate strap and heart rate grips that allow you to your heart automatically. Your goal will be to keep your exercise heart rate at 60 to 90 percent of the theoretical maximum for your age as listed on the Target Heart Rate table and graph in chapter 6.

NOTE: The Heart Rate monitor is not a medical test, nor is it designed as a medical test. It is simply a guide to target heart rate training. Please consult with your physician prior to engaging in any strenuous physical activity.

IMPORTANT: The manufacturer does not warrant the heart rate system performance on this product, as the heart rate system performance varies, based on a user's physiology, fitness level, age, method of use and other factors. Furthermore, the heart rate system is not for medical use.

CONTACT HEART RATE MONITORING



You may use the heart rate contact grips to automatically check your heart rate. Just follow these steps:

1. Grasp the stainless steel heart rate contact grips; you do not have to squeeze tightly.
2. When a heart rate has been detected, the  indicator illuminates, indicating a calculation is taking place. The Information Window displays "HR DETECTED".
3. When your heart rate has been acquired, the  indicator will begin pulsating, and your heart rate in beats per minute (BPM) will be displayed in the Heart Rate Window continuously.
4. Release the Heart Rate grips if you wish to remove your heart rate from the display.

NOTE: Contact heart rate may not give accurate BPM when exercising over 4.0 mph.

CHEST STRAP HEART RATE MONITORING

You may use the heart rate strap to automatically check your heart rate. Just follow these steps:

1. Before beginning your workout, or during a pause, moisten the back of the transmitter on the heart rate strap (not included). Place the strap snugly around your chest with the transmitter resting directly over your sternum.
2. When a heart rate has been detected, the  indicator illuminates, indicating a calculation is taking place. The Information Window displays "HR DETECTED".
3. When your heart rate has been acquired, the  indicator will begin pulsating, and your heart rate in beats per minute (BPM) will be displayed in the Heart Rate Window continuously.
4. Remove the heart rate strap, if you wish to remove your heart rate from the display.

NOTE: The performance of the transmitter may be affected by body types, body oils, metal in clothing, and outside electrical interference. Always be sure that the transmitter and skin are in good contact. Avoid operating other electrical equipment near your treadmill when you use the heart rate strap.

Operating the **STAR TRAC PRO S TREADMILL** is very easy. Simply step onto the running belt, press **QUICK START**, and begin walking or running naturally.

Learning the features and incorporating the **STAR TRAC PRO S TREADMILL** into your members' fitness programs is just as easy. In this chapter, you will learn the display function and how to get the most out of every **STAR TRAC PRO S TREADMILL** workout.

IMPORTANT: Before operating the treadmill, you must be familiar with the following equipment limitations and safety features.

- **Maximum Weight:** Your **STAR TRAC PRO SERIES** Treadmill is designed for a maximum user weight of 350 lbs/159 kg. **DO NOT** exceed the maximum user weight.



- **Emergency Stop:** In case of emergency, press the **STOP** on the display, or the stop switch on the left-hand side rail.
- **Immobilizing the Running Belt:** To power the unit, set the **ON/OFF** power breaker to the **ON** position. To turn the unit off, set the **ON/OFF** power breaker to the **OFF** position. When the unit is turned off, movement of the running belt is prevented.

DISPLAY CONTROL PANEL FEATURES

Your **STAR TRAC PRO S TREADMILL** is equipped to provide you and your users unlimited exercise opportunities. Experiment with its features to find the right combination for your fitness regimen. The Display panel shown below provides the operating controls and display elements described in the following paragraphs:

QUICK START

QUICK START Key: Starts your treadmill running belt moving using a default weight of 155 pounds and a time limit of 99 minutes.

START

START Key: Allows for manual operation of the treadmill. The **START** key also serves as an "Enter" key in programming modes.

STOP



STOP Key: Pauses your treadmill when pressed once. Ends your workout when pressed twice.

Graphic Display: Traces your progress through each of the programs and allows you to anticipate changes in terrain. Display elements illuminate from left to right across the bottom of the display to indicate your progress through the course. At each step, display elements illuminate in columns to indicate your ascent up the gradient that is in effect.

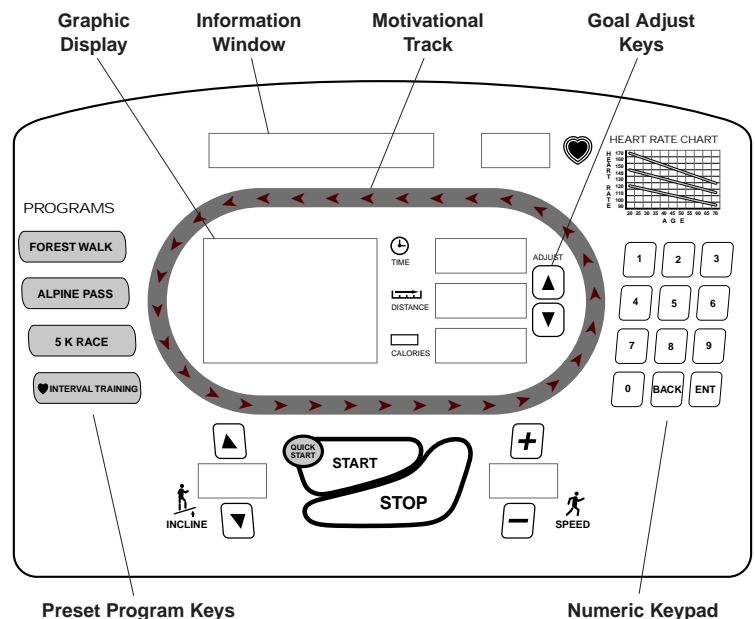
Motivational Track: Shows your progress counter clockwise around 1/4 mile (400-meter) course, starting from the bottom center.

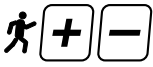



Speed Keys: Adjust running belt speed in 0.1 miles per hour (mph) or 0.1 kilometers per hour (km/hr) increments. To increase or decrease your speed, press the  or  keys, respectively, until the desired speed appears in the Information Window, then, press START. The speed cannot be higher than the established MX SPD parameter (see Chapter 8.) These keys repeat when pressed and held.

Speed Window: Shows the speed at which the user is walking/running, from 0.5 mph (0.8 kph) to 10.0 mph (16.0 kph) for 110-volt units, or 0.5 mph (0.8 kph) to 12.0 mph (19.3 kph) for 220-volt units.



Incline Keys: Adjust treadmill incline in 0.5% increments from 0% through 15% in manual operation. These keys repeat when pressed and held.

Incline Window: Shows the incline that the user is ascending, from 0% (easiest) to 15% (most difficult).



Numeric Keypad: Allow you to enter specific values for program parameters during program setup. The numeric keypad can also be used to adjust treadmill speed while the treadmill is operating.



Time Window: Shows the duration of your workout thus far in minutes and seconds.



Distance Window: Shows the total number of miles or kilometers you have walked or run thus far.



Calorie Window: Shows your aggregate caloric expenditure thus far in your workout.



Goal Adjust Keys : Allow you to increase or decrease your time goal during a workout.

Heart Rate Window: Shows your current heart rate in beats per minute (BPM) while wearing the heart rate strap or grasping the heart rate grips.

Preset Program Keys: Allow you to access a desired preset workout program.

Information Window: Provides informational messages, prompts during program setup, notification when your workout is complete, and scrolling summarized workout data during and after a workout. Depending on the program completed and treadmill settings as set in Manager or Maintenance Settings mode, workout data may include:

- Time consumed
- Calories expended
- Horizontal distance travelled - miles or kilometers
- Average incline
- Average speed - mph or kph
- Workout time remaining
- Distance remaining - miles or kilometers
- Calories remaining
- Laps completed
- Calories expended per hour
- Minutes per mile/kilometer
- METS
- WATTS
- Heart Rate
- Vertical distance travelled - feet or meters

Every 2000 miles (or 3000 km) the Start-Up Display will also scroll REWAX BELT. See Preventive Maintenance, Chapter 7, for additional information.

HINTS AND TIPS FOR GETTING STARTED









The following hints and tips will assist in training your users to maximize the fitness benefits of your *STAR TRAC PRO S TREADMILL*.

- **Walk or run at a rate that feels comfortable and most natural, yet is sufficiently vigorous to get a good cardio workout.**
- **Try different walking or running rhythms.** In manual operation, adjust your pace from low speed to high speed, then back to low. As you become more comfortable with your treadmill, try going faster or using the preset programs.
- **Watch the Graphic Display to anticipate terrain changes.** When you use the preset programs, the display shows changes in terrain as tall or short columns. The display also notifies you of incline changes with a series of beeps and a flashing display element.

QUICK START

Quick Start lets you begin your workout by simply pressing one key. Quick Start uses a default weight of 155 pounds and a time limit of 99 minutes. YOU control the treadmill speed, incline and distance for up to the maximum allowed program time.

To operate the Quick Start program:

1. Stand on the running belt and press the QUICK START key. The running belt slowly accelerates to its minimum speed of 0.5 mph (0.8 kph).
2. You can adjust the incline of the treadmill during the program:
 - You can adjust treadmill incline from 0 to 15%, in 0.5% increments. Press the  key to increase the treadmill incline; press the  key to decrease the treadmill incline.
3. You can adjust the speed of the treadmill during the program:
 - You can specify a desired speed from 0.5 to 10.0 mph (0.8 to 16.0 kph) for 110-volt units or 0.5 to 12.0 mph (0.8 to 19.3 kph) for 220-volt units, using the numeric keypad. Use the ... keys to enter your desired speed, then press the START or ENTER key to accept the entered speed.
 - You can adjust treadmill speed from 0.5 to 10.0 mph (0.8 to 16.0 kph) for 110-volt units or 0.5 to 12.0 mph (0.8 to 19.3 kph) for 220-volt units, in 0.1 mph (or 0.1 kph) increments. Press the  key to increase the treadmill speed; press the  key to decrease the treadmill speed.
4. You can adjust your time goal during the program:
 - You can adjust your time goal from 5 minutes to the maximum allowed program time. Press the ADJUST  key to increase your time goal; press the ADJUST  key to decrease your time goal.
5. You can pause the program during your workout by pressing the STOP key once. The program will pause for a preset period of time (either 30, 45 or 60 seconds, as set in the Manager Settings mode). Press the START key BEFORE the pause timer expires to resume your program. The treadmill returns to its minimum speed when you exit the pause mode.
6. When you have reached your workout goal, the treadmill will enter the Cooldown cycle (see “Cooldown Cycle” for more information). If you wish to exit your program before you have reached your workout goal, press the STOP key twice. The treadmill will slow to a stop. (Press the STOP key once during a Pause to exit the program.)

PRESET PROGRAMS











The PRO S Treadmill offers four preset programs to add variety and challenge to your workout.

FOREST WALK AND ALPINE PASS

The FOREST WALK and ALPINE PASS programs were designed for optimal interval training. By taking you through various terrains, your caloric expenditure is maximized and your cardiovascular capacity is improved. When wearing the heart rate strap, or grasping the heart rate contacts, your heart rate is constantly monitored and displayed in the Heart Rate Window to assist you in getting the most efficient workout possible. The FOREST WALK provides an easy workout, while the ALPINE PASS offers a higher level of intensity.

To operate the FOREST WALK or ALPINE PASS program:

During program setup, you can use the BACK key to return to a previously accepted parameter.

1. Stand on the running belt and press the  or  key, as desired. You are prompted to enter your weight.
 - The treadmill will display a default weight of 155 pounds (70 kg). You may enter any weight from 0 to 350 pounds (0 to 135 kg).
 - You can enter your weight using the numeric keypad. Use the ... keys to enter your correct weight.
 - You can press the  or  key, as necessary, to increase or decrease the displayed weight in 1 pound (or 1 kg) increments.
 - When your correct weight has been entered, press the START or ENTER key to accept the displayed value and advance to the next workout parameter.
2. You are prompted to enter a time goal.
 - The default time goal is 20 minutes. You may enter any time goal from 5 minutes to the maximum allowed program time.
 - You can enter your time goal using the numeric keypad. Use the ... keys to enter the desired time goal.
 - You can press the  or  key, as necessary, to increase or decrease your time goal in 1 minute increments.
 - When your desired time goal has been entered, press the START or ENTER key to accept the displayed value and advance to the next workout parameter.
3. You are prompted to enter a maximum speed.

- You can enter the maximum speed using the numeric keypad. Use the **0**...**9** keys to enter the desired maximum speed.
 - You may enter any speed from 0.5 to 10.0 mph (0.8 to 16.0 kph) for 110-volt units or 0.5 to 12.0 mph (0.8 to 19.3 kph) for 220-volt units.
 - You can press the **▲** or **▼** key, as necessary, to increase or decrease the maximum speed in 0.1 unit increments.
 - When the desired maximum speed has been entered, press the **START** or **ENTER** key to accept the displayed value and advance to the next workout parameter.
4. You are prompted to enter a maximum incline.
- You may enter any incline from 0.0% to 15.0%
 - You can enter the maximum incline using the numeric keypad. Use the **0**...**9** keys to enter the desired maximum incline.
 - You can press the **▲** or **▼** key, as necessary, to increase or decrease the maximum incline in 0.5% increments.
 - When the desired maximum incline has been entered, press the **▲** key to accept the displayed value. You are prompted with a 3 second countdown, then the treadmill begins the program.
5. You can adjust the incline of the treadmill during the program:
- NOTE:** Changing the current incline during a program will result in a corresponding change to the maximum incline specified during program setup.
- You can adjust treadmill incline from 0 to 15%, in 0.5% increments. Press the **▲** key to increase the treadmill incline; press the **▼** key to decrease the treadmill incline.
6. You can adjust the speed of the treadmill during the program:
- NOTE:** Changing the current speed during a program will result in a corresponding change to the maximum speed specified during program setup.
- You can specify a desired speed from 0.5 to 10.0 mph (0.8 to 16.0 kph) for 110-volt units or 0.5 to 12.0 mph (0.8 to 19.3 kph) for 220-volt units, using the numeric keypad. Use the **0**...**9** keys to enter your desired speed, then press the **START** or **ENTER** key to accept the entered speed.
 - You can adjust treadmill speed from 0.5 to 10.0 mph (0.8 to 16.0 kph) for 110-volt units or 0.5 to 12.0 mph (0.8 to 19.3 kph) for 220-volt units, in 0.1 mph (or 0.1 kph) increments. Press the **▲** key to increase the treadmill speed; press the **▼** key to decrease the treadmill speed.
7. You can adjust your time goal during the program:
- You can adjust your time goal from 5 minutes to the maximum allowed program time. Press the **▲** key to increase your time goal; press the **▼** key to decrease your time goal.
8. You can pause the program during your workout by pressing the **STOP** key once. The program will pause for a preset period of time (either 30, 45 or 60 seconds, as set in the Manager Settings mode). Press the **START** key BEFORE the pause timer expires to resume your program. The treadmill returns to its minimum speed when you exit the pause mode.
9. When you have reached your workout goal, the treadmill will enter the Cooldown cycle (see “Cooldown Cycle” for more information). If you wish to exit your program before you have reached your workout goal, press the **STOP** key twice. The treadmill will slow to a stop. (Press the **STOP** key once during a Pause to exit the program.)

5 K RACE

The 5 K RACE program was designed for the serious, as well as the recreational runner. You control the speed and incline to add variety and challenge to your workout. The patented Impact Absorption System™ (IAS) protects ankles, knees, joints and back while providing a comfortable run. When wearing the heart rate strap, or grasping the heart rate contacts, your heart rate is constantly monitored and displayed in the Heart Rate Window to assist you in getting the most efficient workout possible.

To operate the 5 K RACE program:

During program setup, you can use the **BACK** key to return to a previously accepted parameter.

1. Stand on the running belt and press the **5 K RACE** key. You are prompted to enter your weight.
 - The treadmill will display a default weight of 155 pounds (70 kg). You may enter any weight from 0 to 350 pounds (0 to 135 kg).
 - You can enter your weight using the numeric keypad. Use the **0**...**9** keys to enter your correct weight.

- You can press the **▲+** or **▲-** key, as necessary, to increase or decrease the displayed weight in 1 pound (or 1 kg) increments.
 - When your correct weight has been entered, press the START or ENTER key to accept the displayed value. You are prompted with a 3 second countdown, then the treadmill begins the program.
2. You can adjust the incline of the treadmill during the program:
 - You can adjust treadmill incline from 0 to 15%, in 0.5% increments. Press the **▲** key to increase the treadmill incline; press the **▼** key to decrease the treadmill incline.
 3. You can adjust the speed of the treadmill during the program:
 - You can specify a desired speed from 0.5 to 10.0 mph (0.8 to 16.0 kph) for 110-volt units or 0.5 to 12.0 mph (0.8 to 19.3 kph) for 220-volt units, using the numeric keypad. Use the **0**...**9** keys to enter your desired speed, then press the START or ENTER key to accept the entered speed.
 - You can adjust treadmill speed from 0.5 to 10.0 mph (0.8 to 16.0 kph) for 110-volt units or 0.5 to 12.0 mph (0.8 to 19.3 kph) for 220-volt units, in 0.1 mph (or 0.1 kph) increments. Press the **▲+** key to increase the treadmill speed; press the **▲-** key to decrease the treadmill speed.
 4. You can pause the program during your workout by pressing the STOP key once. The program will pause for a preset period of time (either 30, 45 or 60 seconds, as set in the Manager Settings mode). Press the START key BEFORE the pause timer expires to resume your program. The treadmill returns to its minimum speed when you exit the pause mode.
 5. When you have reached your workout goal, the treadmill will enter the Cooldown cycle (see “Cooldown Cycle” for more information). If you wish to exit your program before you have reached your workout goal, press the STOP key twice. The treadmill will slow to a stop. (Press the STOP key once during a Pause to exit the program.)

♥ INTERVAL TRAINING

Program Definition

This heart rate feature is designed to gradually elevate your heart rate to the upper end of your selected training range, then gradually decrease your heart rate to the lower end of your selected training range using speed and incline. During the workout, this cycle will repeat several times, creating an interval training effect that is customized to the user's desired heart rate training range.

During program setup, there must be at least an 18 BPM difference between the lower heart rate limit and upper heart rate limit to ensure an interval workout.

Benefits of Heart Rate Intervals

By including interval exercise in your regular aerobic program, greater effects are noticed. Your heart and muscles will adapt to the increases in demand by utilizing stored calories for energy more effectively. Dynamic Heart Rate Control may potentially result in more calories expended. It will strengthen the heart, provide stress relief and variety to a workout. This program is more effective in training the body to remove excess lactic acid from the muscles.

How to Use ♥ Interval Training

NOTE: For best results, use a heart rate strap. If user is wearing a heart rate strap, the machine will automatically use the data from the heart rate strap. Contact heart rate grips may not give an accurate heart rate when exercising over 4 mph.

During program setup, you can use the BACK key to return to a previously accepted parameter.

1. Stand on the running belt; press the **♥ INTERVAL TRAINING** key. The Information Window displays the message “DYNAMIC HR CONTROL”. Press the START or ENTER key to continue.
2. The Information Window displays the message “INTERVAL PROGRAM VARIES SPEED AND INCLINE TO ALTER YOUR HEART RATE BETWEEN LIMITS, SELECT UPPER AND LOWER HEART RATE LIMITS”. Press the START or ENTER key to continue.
3. You are prompted to enter your weight.
 - The treadmill will display a default weight of 155 pounds (70 kg). You may enter any weight from 0 to 350 pounds (0 to 135 kg).
 - You can enter your weight using the numeric keypad. Use the **0**...**9** keys to enter your correct weight.

To calculate your training zone, use the following formulas:
(theoretical max HR = 220 - Age)

Heart Rate Training Range Upper Level

$$\frac{\text{Your Theoretical Max}}{\text{Your Theoretical Max}} \times 0.75 = \frac{\text{Training Range Upper Limit}}{\text{Training Range Upper Limit}}$$

Heart Rate Training Range Lower Level







$$\frac{\text{Your Theoretical Max}}{\text{Your Theoretical Max}} \times 0.60 = \frac{\text{Training Range Lower Limit}}{\text{Training Range Lower Limit}}$$

- You can press the **▲+** or **▲-** key, as necessary, to increase or decrease the displayed weight in 1 pound (or 1 kg) increments.
 - When your correct weight has been entered, press the START or ENTER key to accept the displayed value and advance to the next workout parameter.
4. You are prompted to enter your age.
- You may enter any age from 1 to 99 years.
 - You can enter your age using the numeric keypad. Use the **0**...**9** keys to enter the desired age.
 - You can press the **▲+** or **▲-** key, as necessary, to increase or decrease your age in 1 year increments.
 - When your correct age has been entered, press the START or ENTER key to accept the displayed value and advance to the next parameter.
5. You are prompted to enter your upper heart rate limit.
- The treadmill displays a default upper heart rate limit based on 75% of the maximum heart rate for your age.
 - You can enter a new upper heart rate limit using the numeric keypad. Use the **0**...**9** keys to enter the desired upper heart rate limit.
 - You can use the **▲+** or **▲-** key, as necessary, to increase or decrease the displayed upper heart rate limit in 1 BPM increments.
 - When the desired upper heart rate limit has been entered, press the START or ENTER key to accept the displayed value and advance to the next parameter.
6. You are prompted to enter your lower heart rate limit.
- The treadmill displays a default lower heart rate limit based on 60% of the maximum heart rate for your age.
 - You can enter a new lower heart rate limit using the numeric keypad. Use the **0**...**9** keys to enter the desired lower heart rate limit.
 - You can use the **▲+** or **▲-** key, as necessary, to increase or decrease the displayed lower heart rate limit in 1 BPM increments.
 - When the desired lower heart rate limit has been entered, press the START or ENTER key to accept the displayed value and advance to the next parameter.
7. You are prompted to enter a maximum speed.
- You may enter any speed from 0.5 to 10.0 mph (0.8 to 16.0 kph) for 110-volt units or 0.5 to 12.0 mph (0.8 to 19.3 kph) for 220-volt units.
 - You can enter the maximum speed using the numeric keypad. Use the **0**...**9** keys to enter the desired maximum speed.
 - You can press the **▲+** or **▲-** key, as necessary, to increase or decrease the maximum speed in 0.1 unit increments.
 - When the desired maximum speed has been entered, press the START or ENTER key to accept the displayed value and advance to the next workout parameter.
8. You are prompted to select a workout goal.
- Use the **0**...**9** keys to select a workout goal: press **1** for time goal, **2** for distance goal or **3** for calories goal.
 - When the desired goal has been selected, press the START or ENTER key to accept the displayed value. You are prompted with a 3 second countdown, then the treadmill begins the program.
- **During the Workout**
1. During the heart rate controlled workout, the treadmill will respond every 20 seconds to your heart rate. The treadmill uses your heart rate to adjust the intensity of the workout. The treadmill will adjust speed and (if necessary) incline to elevate your heart rate to the specified upper limit, then it will gradually decrease incline and (if necessary) speed to lower your heart rate to the specified lower limit. A typical 20 minute workout may repeat this pattern 3 to 5 times.
 2. The program will display various motivational and informative messages throughout the workout. After the workout is complete, the program will scroll the summary workout information.
 3. If, for any reason, the treadmill does not detect your heart rate signal, the treadmill will gradually decrease the workout intensity. After the heart rate signal is re-acquired the interval training program will resume.

COOLDOWN CYCLE

Once you have completed your workout program, the treadmill enters a 2-minute cooldown cycle.

To operate the treadmill during Cooldown:

1. You can adjust the incline of the treadmill during the program:
 - You can adjust treadmill incline from 0 to 15%, in 0.5% increments. Press the  key to increase the treadmill incline; press the  key to decrease the treadmill incline.
2. You can adjust the speed of the treadmill during the program:
 - You can specify a desired speed from 0.5 to 10.0 mph (0.8 to 16.0 kph) for 110-volt units or 0.5 to 12.0 mph (0.8 to 19.3 kph) for 220-volt units, using the numeric keypad. Use the ... keys to enter your desired speed, then press the START or ENTER key to accept the entered speed.
 - You can adjust treadmill speed from 0.5 to 10.0 mph (0.8 to 16.0 kph) for 110-volt units or 0.5 to 12.0 mph (0.8 to 19.3 kph) for 220-volt units, in 0.1 mph (or 0.1 kph) increments. Press the  key to increase the treadmill speed; press the  key to decrease the treadmill speed.
3. When the cooldown cycle ends, the treadmill will slow to a stop. If you wish to exit the cooldown cycle before it ends automatically, press the STOP key. The treadmill will slow to a stop.

HEART RATE MONITORING



Heart rate monitoring allows you to determine if your treadmill workout is too challenging or not challenging enough. Monitoring heart rate is easy with the **STAR TRAC PRO S TREADMILL**, which provides both a heart rate strap and heart rate grips that allow you to your heart automatically. Your goal will be to keep your exercise heart rate at 60 to 90 percent of the theoretical maximum for your age as listed on the Target Heart Rate table and graph in chapter 6.

NOTE: The Heart Rate monitor is not a medical test, nor is it designed as a medical test. It is simply a guide to target heart rate training. Please consult with your physician prior to engaging in any strenuous physical activity.

IMPORTANT: The manufacturer does not warrant the heart rate system performance on this product, as the heart rate system performance varies, based on a user's physiology, fitness level, age, method of use and other factors. Furthermore, the heart rate system is not for medical use.

CONTACT HEART RATE MONITORING



You may use the heart rate contact grips to automatically check your heart rate. Just follow these steps:

1. Grasp the stainless steel heart rate contact grips; you do not have to squeeze tightly.
2. When a heart rate has been detected, the  indicator illuminates, indicating a calculation is taking place. The Information Window displays "HR DETECTED".
3. When your heart rate has been acquired, the  indicator will begin pulsating, and your heart rate in beats per minute (BPM) will be displayed in the Heart Rate Window continuously.
4. Release the Heart Rate grips if you wish to remove your heart rate from the display.

NOTE: Contact heart rate may not give accurate BPM when exercising over 4.0 mph.

CHEST STRAP HEART RATE MONITORING

You may use the heart rate strap to automatically check your heart rate. Just follow these steps:

1. Before beginning your workout, or during a pause, moisten the back of the transmitter on the heart rate strap (not included). Place the strap snugly around your chest with the transmitter resting directly over your sternum.
2. When a heart rate has been detected, the  indicator illuminates, indicating a calculation is taking place. The Information Window displays "HR DETECTED".
3. When your heart rate has been acquired, the  indicator will begin pulsating, and your heart rate in beats per minute (BPM) will be displayed in the Heart Rate Window continuously.
4. Remove the heart rate strap, if you wish to remove your heart rate from the display.

NOTE: The performance of the transmitter may be affected by body types, body oils, metal in clothing, and outside electrical interference. Always be sure that the transmitter and skin are in good contact. Avoid operating other electrical equipment near your treadmill when you use the heart rate strap.

PERSONAL TRAINER STUDIO™

The unique Personal Trainer Studio™ was developed by Star Trac in conjunction with focus groups of the personal training industry. The Personal Trainers told Star Trac that they needed three things: customization of their clients workouts, accountability - meaning having their clients actually perform the amount and intensity of cardio exercise that is prescribed, and feedback to the user so that they can accurately assess their cardio progress. We give you the system to meet all of these needs, with the Personal Trainer Studio™. This chapter provides the procedures to manage Personal Trainer PIN codes, and to add, edit and delete programs. For the procedures to run Personal Trainer programs, refer to Chapter 3, Pro Operation.

NOTE: The Personal Trainer Studio™ is available on the **PRO / PRO ELITE TREADMILL** only.

USING PERSONAL TRAINER STUDIO™

After you have been assigned a PIN number by the Club Coordinator or manager, you may now enter the Personal Trainer Studio™. Personal Trainer Studio™ is simple to understand and simple to use. The following chart defines the basic functionality of this feature.

Custom programs: Each trainer is assigned a PIN code by the club or fitness director. Each PIN code allows storage of 5 custom programs with up to 20 intervals each. Your personal profiles can be further customized to suit specific client needs by entering a maximum speed at run time. The level control scales the elevation of the profile while the Max Speed entry ensures that your client will not exceed their abilities.

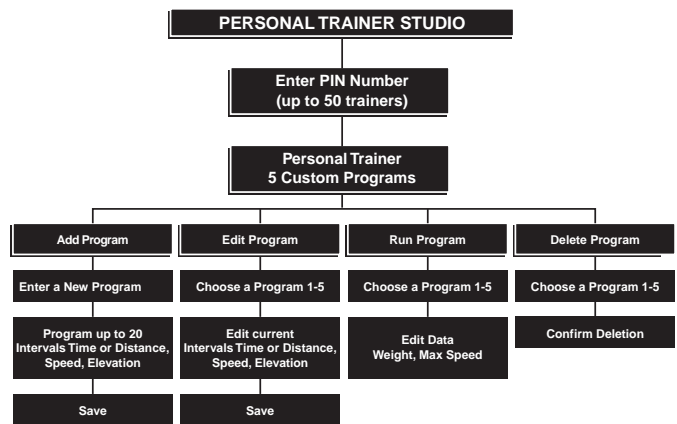

MAINTAINING PIN NUMBERS:

The master PIN code is required to assign and add or delete personal trainer PIN numbers. The following chart shows the basic procedures for maintaining Personal Trainer PIN numbers.

To add a Personal Trainer PIN Code:

1. Press the **PERSONAL TRAINER STUDIO** key; you will be prompted to enter a PIN code.
2. Use the **0...9** keys to enter the MASTER PIN code, then press the START or ENTER key.
3. Press the **1** key to enter the “Add PIN” function. Use the **0...9** keys to enter the desired PIN. You may use any number from **0000** to **9999**.
4. Press the START or ENTER button to add the new PIN number. The Information Window will display a confirmation message indicating that the PIN number has been added to the system.

If the entered PIN number currently exists in the system, or if the added PIN number would exceed the maximum number of PINs allowed (50), an error message will display in the Information Window.





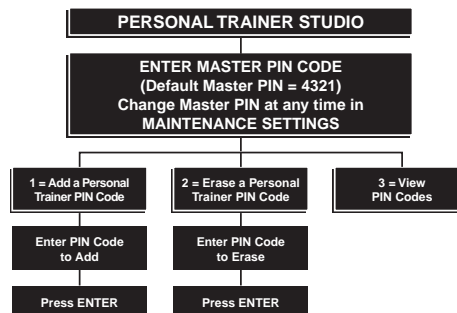

To delete a Personal Trainer PIN Code:

1. Press the **PERSONAL TRAINER STUDIO** key; you will be prompted to enter a PIN code.
2. Use the **0...9** keys to enter the MASTER PIN code, then press the START or ENTER key.
3. Press the **2** key to enter the “Delete PIN” function.
4. Use the **+/-** keys to scroll through the list of active PIN numbers until the desired PIN number is displayed.



5. Press the START or ENTER button to delete the currently displayed PIN number. Press the START or ENTER button a second time to confirm the deletion.
6. If desired, repeat steps 4 and 5 to delete additional PIN numbers. When all desired PIN numbers have been deleted, press the STOP button to exit the “Delete PIN” function.





To view active PIN numbers:







1. Press the  key; you will be prompted to enter a PIN code.
2. Use the ... keys to enter the MASTER PIN code, then press the START or ENTER key.
3. Press the  key to enter the “View PIN” function.
4. Use the    keys to scroll through the list of active PIN numbers until the desired PIN number is displayed.
5. Press the STOP button to exit the “View PIN” function.

MANAGING CUSTOM PROGRAMS

Each Personal Trainer PIN code allows storage of 5 custom programs with up to 20 intervals each. Each program can be configured to provide either a “Time” or “Distance” goal. If desired, make a copy of the PERSONAL TRAINER STUDIO™ PROGRAM WORKSHEET on the following page to aid in developing your custom programs, then refer to the WORKSHEET to enter the program data using the following procedures.

To add a custom program:

When entering program parameters, or use the ... keys to enter the desired value, or use the    keys to scroll to the desired value.

1. Press the  key; you will be prompted to enter a PIN code.
2. Use the ... keys to enter your personal PIN code, then press the START or ENTER key.
3. Press the  key to enter the “Add Program” function.
4. Press the  key to add a program with a “Time Goal”; press the  key to add a program with a “Distance Goal”. The Information Window will display a prompt to enter a time goal, or distance goal, as appropriate:

Time Goal - The default time goal is 20 minutes. You may enter any time goal from 5 to 99 minutes.

Distance Goal - The default distance goal is 5 miles (English units) or 5 kilometers (metric units). You may enter any distance goal from 5 miles (5 kilometers) to 19.80 miles (31.86 kilometers).

5. When the desired goal value has been entered, press the START or ENTER key to accept the current value.
6. The Information Window will display a prompt to enter a time goal or distance goal, as appropriate, for the first segment of the program:

Time Goal - The default segment time goal is 4 minutes. You may enter any time goal from 1 minute to the remaining goal time.

Distance Goal - The default distance goal is 1 mile (English units) or 1 kilometer (metric units). You may enter any segment distance goal from 0.10 miles (0.10 kilometers) to the remaining goal distance.

7. When the desired segment goal value has been entered, press the START or ENTER key to accept the current value.
8. The Information Window will display a prompt to enter a speed for the first segment of the program.
You may enter any speed from 0.5 to 10.0 mph (0.8 to 16.0 kph) for 110-volt units or 0.5 to 12.0 mph (0.8 to 19.3 kph) for 220-volt units, in increments of 0.1 units.
9. When the desired segment speed value has been entered, press the START or ENTER key to accept the current value and proceed to the next parameter.
10. The Information Window will display a prompt to enter an incline for the first segment of the program.

You may enter any incline from 0.0 to 15.0%, in increments of 0.5%.

11. When the desired segment incline value has been entered, press the START or ENTER key to accept the current value and proceed to the next segment.
12. The Information Window will display prompts for additional program segments. Continue to enter the desired goal (time or distance, as appropriate), speed and incline until values for all segments of the program have been entered. The system will continue to prompt for segment values until one of the following conditions is met:

PERSONAL TRAINER STUDIO PROGRAM WORKSHEET







Personal Trainer Password:

	PROGRAM 1			PROGRAM 2			PROGRAM 3			PROGRAM 4			PROGRAM 5		
	<input type="checkbox"/> TIME GOAL: _____			<input type="checkbox"/> TIME GOAL: _____			<input type="checkbox"/> TIME GOAL: _____			<input type="checkbox"/> TIME GOAL: _____			<input type="checkbox"/> TIME GOAL: _____		
	<input type="checkbox"/> DIST. GOAL: _____			<input type="checkbox"/> DIST. GOAL: _____			<input type="checkbox"/> DIST. GOAL: _____			<input type="checkbox"/> DIST. GOAL: _____			<input type="checkbox"/> DIST. GOAL: _____		
	Time / Dist.	Speed	Incline	Time / Dist.	Speed	Incline	Time / Dist.	Speed	Incline	Time / Dist.	Speed	Incline	Time / Dist.	Speed	Incline
Interval 1															
Interval 2															
Interval 3															
Interval 4															
Interval 5															
Interval 6															
Interval 7															
Interval 8															
Interval 9															
Interval 10															
Interval 11															
Interval 12															
Interval 13															
Interval 14															
Interval 15															
Interval 16															
Interval 17															
Interval 18															
Interval 19															
Interval 20															







NOTE: 1. Users can either be assisted into their training program, or the Personal Trainer can give their PIN number to the user individually.
2. Managers - be sure to keep track of all Personal Trainer PIN numbers.

- The total number of segments equals 20.
- The combined value of the segment goals is equal to the total goal.

To edit a custom program:

1. Press the  key; you will be prompted to enter a PIN code.
2. Use the ... keys to enter your personal PIN code, then press the START or ENTER key.
3. Press the  key to enter the “Edit Program” function.
4. Press the desired ... key to select a program for deletion. Press the START or ENTER key to begin editing the selected program (press the STOP key to leave the program unchanged and return to the top of the “Edit Program” function).
5. The system will display the current values for the program time goal or distance goal, as appropriate, segment goals, segment times and segment inclines, in sequence. Edit the parameters, as desired, using the same procedures as for adding a program.

To delete a custom program:

1. Press the  key; you will be prompted to enter a PIN code.
2. Use the ... keys to enter your personal PIN code, then press the START or ENTER key.
3. Press the  key to select the “Delete Program” function.
4. Press the desired ... key to select a program for deletion.
5. Press the START or ENTER button to delete the selected program (press the STOP key to cancel the deletion and return to the top of the “Delete Program” function). Press the START or ENTER button a second time to confirm the deletion.
6. The Information Window will display a confirmation message indicating that the selected program has been deleted. If desired, delete additional programs as described in steps 4 through 6, above.
7. When all desired programs have been deleted, press the STOP key to exit the “Delete Program” function.

To assist you in your training program, this chapter provides you with exercise principles, tips for training and hints to stay motivated climbing up the conditioning ladder.

THE FIRST STEP TO A BETTER LIFESTYLE

With the **STAR TRAC PRO S / PRO / PRO ELITE TREADMILL**, you've taken an important first step to achieving your fitness goal. But, it's important to have the right fitness tools to stay motivated and achieve results. About half of all people who start an exercise program quit within 6-12 months. What is the key to success for the other half? Motivation!

As you may know, exercise reduces the factors associated with the development of heart disease, hypertension, diabetes, obesity and back disorders. Researchers have concluded that a healthful life-style including regular exercise can extend your life expectancy by as much as fifteen years! More importantly, exercise will help make all your years - no matter how many there are - productive and enjoyable.

What constitutes a regular exercise regimen? If you stick with a consistent workout program for 30 minutes, three times a week, for 3 months, you will be on your way to a long-term fitness program. Part of the motivation for a regular exercise regimen will stem from the results you will both see and feel after three months. In fact, many exercisers start to experience results in as early as one week!

GETTING STARTED - WALKERS AND RUNNERS

For fitness newcomers or veterans, the **STAR TRAC PRO S / PRO / PRO ELITE TREADMILL** offers tailor-made walking and running programs. The following information will be useful when developing your own exercise program.

Assessing Fitness Level

Conducting a cardiovascular endurance assessment is a great way to start an exercise regimen. With the simple 1 mile Fit Test on your Star Trac PRO **SERIES** treadmill, the results provide great baseline information to help determine your proper workout intensity levels, and it serves as a great motivational tool for showing improvements over time. Below is a simple test to follow. This assessment should only be used with apparently healthy adults.

The Fit Test is a modified version of the Balke and Ware protocol for maximal VO₂ treadmill testing. The Fit Test requires 12 minutes to complete. During the Fit Test, treadmill speed remains at a constant 3.4 mph. Treadmill incline is set at 0% during the first minute, increases to 2% during the second minute, and increases by 1% per minute for the remainder of the test. Your heart rate results are compared with charted data for your corresponding age and gender. Test results are given on a scale of 1 to 10, and include your calculated VO₂ max. VO₂ max is a physiological measurement of a body's ability to absorb oxygen and has specific correlation to your fitness level.

The Warm Up

Warming-up prepares you for physical activity by increasing body temperature, allowing the muscles to relax and contract more smoothly and efficiently, and lubricating the joints. Good warm-up exercises include walking, bicycling, jogging and light calisthenics. Proper warm-up may also help prevent injuries and reduce the likelihood of cardiac abnormalities. A mild sweat is a good indication that the body is sufficiently warmed-up.

Pre-Exercise Stretching

A flexibility program prior to walking or running is designed to help improve performance and reduce the risk of injury during the activity. When you are stretching, remember these simple rules:

- An active warm-up is recommended prior to vigorous stretching exercises. If stretches are performed, they should be done with caution, so as to not over stretch muscles.
- Do not force a stretch. The degree of stretching should not cause significant pain.
- Hold the stretch for 10 to 15 seconds without bouncing.
- Repeat each stretch two or three times for increased flexibility.
- Try to maintain good posture and remember to breathe during the stretch.

The following muscle groups should be stretched/warmed up for any walking or running program:

- | | | |
|--------------|----------------|--------------------|
| ■ Quadriceps | ■ Glutes | ■ Chest |
| ■ Hamstrings | ■ Inner thighs | ■ Shoulder muscles |
| ■ Calves | ■ Back muscles | ■ Hip flexors |

F.I.T. Principle

Every cardiovascular program should be developed based on frequency, intensity and duration.

1) **Frequency** - the number of exercise sessions per week.

Regular exercise should be performed at least three or four days a week to be beneficial, although fewer sessions may be sufficient for some. Those in superior physical condition typically train five to seven days per week.

2) **Intensity** - how hard each exercise is.

Intensity is dependent upon one's fitness level. The range established by American College of Sports Medicine is 60% to 90% of maximal heart rate. If you are a beginning exerciser, maintaining an intensity level around 60% is beneficial. Typically, an estimated heart rate range is determined using a formula of 220-Age, factoring in resting heart rate, then multiplying by the desired percentage. See the accompanying chart on this page.

The **STAR TRAC PRO S / PRO / PRO ELITE TREADMILL** offers both contact heart rate grips and heart rate strap compatibility, providing for easy monitoring of your heart rate during your workout. However, if you need to monitor your pulse manually, find the carotid or radial artery with your index finger, take a ten second count and multiply by six to determine your heart rate.

RPE SCALE	
0	Nothing at all
1	Very, Very Easy
2	Very Easy
3	Easy
4	Moderate
5	Moderate/Strong
6	Strong
7	Very Strong
8	Very, Very Strong
9	Extremely Strong
10	Strongest

Another common method for measuring workout intensity is Rate of Perceived Exertion (RPE). This method provides a scale in which an exerciser can subjectively determine how hard the exercise feels while working in a target training range. Descriptive words correspond with a 0 through 10 rating scale. The target range to exercise is between 4 and 6 on the rating scale. (This is a great method to use for those taking medications that effect one's heart rate and for those who want to fine tune how to be in touch with how their bodies respond to exercise). See the accompanying chart on this page.

3) **Time** - the duration of each exercise session.

The optimum duration of an exercise session depends on the intensity. Typically, an exercise session lasts for at least 20 to 30 minutes, although highly conditioned individuals often train continuously for an hour or longer. The duration of training is sometimes increased while intensity is decreased. This happens early in the training program to prepare the musculoskeletal system for vigorous exercise and to reduce the chance of injury.

REMEMBER: Use the F.I.T. principle as a guide to establish your program, however, make sure that you pay attention to how your body feels. Under-exercising may not be adequate for desired results. However, over-exercising can lead to injuries. Be sure to start slowly, and pace yourself.

The Cool Down

A gradual cool down helps prevent blood from pooling in your legs which may result in feeling light headed and dizzy. Active contraction by continuous movement of your legs and arms during the cool down helps pump blood back to your heart and brain. It is also important to stretch your muscles during the cool down. Use stretching exercises similar to those done during the warm up (see muscles listed in the warm up section). Stretching in this phase can be held for a longer period to help avoid muscle stiffness.

CLIMBING THE CONDITIONING LADDER - SUGGESTED PROGRAMS

The programs outlined below were developed by the director of services at the Lutheran General Hospital in Illinois. They were developed to help maintain or improve one's level of fitness, depending on the current fitness level. Follow each of the 6 week programs as they move in progression. Once Program V is achieved, continue at this same level of intensity for continued programs, however, add variety by changing around workouts per week, duration or add interval training (high intensity mixed with low intensity 70% - 90%). To add variety to intensity make, use of the incline feature on the Star Trac PRO /PRO S Treadmill. This feature gives you an incline range from 0% to 15%.

Determining your Target Heart Rate Range

LOWER TARGET HEART RATE

$$\begin{aligned}
 & 220 \\
 - & \text{Your Age} \\
 = & \text{Estimated Max. Heart Rate} \\
 - & \text{Your Resting Heart Rate} \\
 = & \text{Value} \\
 \times & 60\% \\
 = & \text{Estimated Target} \\
 + & \text{Your Resting Heart Rate} \\
 = & \text{Target Heart Rate @ 60\%}
 \end{aligned}$$

UPPER TARGET HEART RATE

$$\begin{aligned}
 & 220 \\
 - & \text{Your Age} \\
 = & \text{Estimated Max. Heart Rate} \\
 - & \text{Your Resting Heart Rate} \\
 = & \text{Value} \\
 \times & 80\% \\
 = & \text{Estimated Target} \\
 + & \text{Your Resting Heart Rate} \\
 = & \text{Target Heart Rate @ 80\%}
 \end{aligned}$$

Lower Target Heart Rate

Upper Target Heart Rate

Program I:			
Week	Heart Rate (%)	Duration (minutes)	Workouts per Week
1,2	60 to 65	15	3
3,4	60 to 65	15	3
5,6	60 to 65	15	3
Program II:			
Week	Heart Rate (%)	Duration (minutes)	Workouts per Week
1,2	65 to 70	20	3
3,4	65 to 70	20	3
5,6	65 to 70	20	3
Program III:			
Week	Heart Rate (%)	Duration (minutes)	Workouts per Week
1,2	70 to 75	20	4
3,4	70 to 75	25	4
5,6	70 to 75	25	4
Program IV:			
Week	Heart Rate (%)	Duration (minutes)	Workouts per Week
1,2	75 to 80	25	4
3,4	75 to 80	25	4
5,6	75 to 80	30	4
Program V:			
Week	Heart Rate (%)	Duration (minutes)	Workouts per Week
1,2	80 to 85	30	4
3,4	80 to 85	35	4
5,6	80 to 85	35	4

PROGRAM VARIATION ON THE PRO / PRO S TREADMILL

Everyone can benefit from using treadmills because walking, jogging, and running provide results. The Star Trac **PRO S / PRO / PRO ELITE** Treadmill gives you infinite workout possibilities. Here are some suggested programs for the deconditioned, average and athletic users.

Deconditioned (beginning) Exercisers

This group, which includes the overweight, cardiac rehabilitated and the senior population, requires more personal attention and one-on-one feedback for motivation rather than fancy programs built into the treadmill. Keeping everything simple is key. Before starting to exercise, becoming acquainted with basic treadmill features, including emergency stop button helps to make the exercise experience more fulfilling. The Quick Start program is a great place to start. The user, at all times has control of his/her workout, and all basic information feedback is provided. Another program recommended for this group is the Heart Training program. This program is great for learning how the heart rate responds to various levels of intensity. However, knowing one's target training range is necessary to operate this program. Starting speed for this group ranges from 2.0 to 3.0 mph. The incline shouldn't exceed 5% elevation unless instructed differently by a fitness professional. Progression of intensity and time is gradual (weekly) and frequency progress may not occur until after 4 weeks.

Average Exercisers

This group is classified by those who live somewhat active lifestyles (exercising about twice a week) or fit into the age category of 18-35. Confidence levels from this group are higher than the deconditioned group, therefore the willingness to try new or more advanced programs is greater. While most tend to enter immediately into a quick start, encouraging use of other programs may keep participation consistent and workouts more alive. The Forest Walk, Trailblazer or Alpine Pass offer great variations that make good use of incline, making a running or walking workout more interesting and challenging. The Heart Training program is a good way to monitor and challenge intensity ranges, which is great for achieving results in a cardiovascular endurance program.

Starting speed for this group ranges from about 3.0 to 3.5 mph. Typically, exercisers in this category will not use elevation, however, it is strongly encouraged for varied intensity and variability. Exercisers in this category may not be comfortable exceeding 10% incline. Progression of intensity and time is gradual (weekly) and frequency progress may not occur until after 4 weeks.

Athletic Exercisers

Competitive and advance exercisers often look for varied programs for sports enhancement or maintenance. A great sports enhancement program is the Custom Interval. This program allows the user to set all parameters of intensity and duration for up to 20 intervals. The Custom Interval program is ideal for speed training, or anaerobic training. If competition is an interest, the 5K and 10K runs offer the user a route to follow and a means to monitor progress. While many of the programs include a warm-up phase, in the Manual Program or Custom Interval make sure a warm-up and cool-down period is factored in. If you are doing a running workout, a good starting speed is 5.0 mph. If you are doing a walking or jogging workout, a good starting speed is 3.8 mph.

Target Training Chart

Use the following table for a quick glance at your target training zone for both heart rate and rate of perceived exertion.

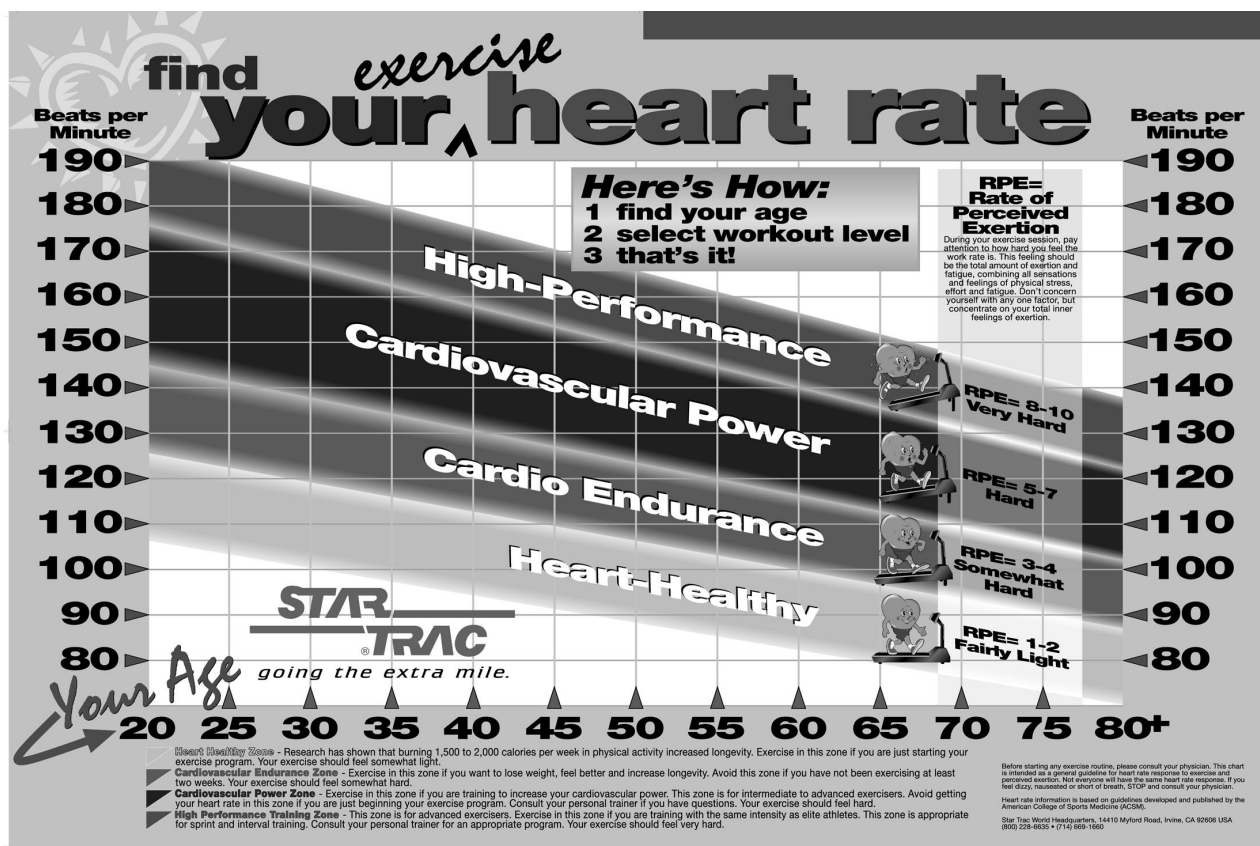

TIPS TO STAY MOTIVATED

Set Goals and Reward yourself: Determine precisely what you want to achieve. By setting challenging, specific goals, you are setting yourself up to achieve them. When you achieve those goals, reward yourself. "It's crucial (to reward yourself)," according to Lauve Metcalfe, Director of Program Development at the Campbell Institute for Health and Fitness in Camden, New Jersey. "Who quits a program because he's having too much fun?" Example of tangible rewards: A new pair of running shoes if you knock a minute off your time in the mile.

Schedule your workout: Get into the habit of working out at the same time each day. And, write that time on your calendar. Make keeping your workout schedule as important as eating or sleeping.

Watch your progress: Follow your movement on the Graphic Display to help pass time and cut down on boredom.

Plan an active vacation: If you know you're going on a walking tour of Paris or on a mountain hiking trip next summer, you'll look forward to getting into shape for it.

Exercise in numbers: Get a workout partner or exercise in a group. This will offer you support and a level of accountability, (not to let your partner or group down for not showing up).

Train for a race or enter an event: A race is a great goal toward which to work, and the excitement of competition is sure to keep you going. Try a 5K or a 10K run.

Avoid too much too soon: Stress and discomfort of an over-aggressive program can be overwhelming and lead to injuries.

Vary your workouts: Once accustomed to a program, vary the workout so that your routine doesn't become mundane. It's also important to recruit new muscle fibers to a new exercise to keep the body stimulated to make improvements.

Star Trac strongly recommends performing regular preventive maintenance on your **STAR TRAC PRO S / PRO / PRO ELITE TREADMILL**. Without regularly scheduled maintenance, normal wear and tear may cause cumulative effects, such as misalignment or premature wear. This may result in downtime. For this reason, we highly recommend following the maintenance schedules. Additionally, unusual symptoms, such as display codes and blown circuit breakers, should be reported to **STAR TRAC PRODUCT SUPPORT DEPARTMENT** at (800) 503-1221, or USA 1-714-669-1660. If any components are found to be worn or damaged, the treadmill should be removed from service until repairs can be made. Only components supplied or approved by Star Trac shall be used to maintain and/or repair the treadmill.

DAILY MAINTENANCE

- Remove excessive accumulations of dust, dirt, and other substances by using a clean soft cloth and a non-abrasive liquid cleaner, such as Formula 409™ or FANTASTIK™. Wipe down the display board, handrails, shroud and heart rate grips.

NOTE: DO NOT spray the cleaner directly onto the display board or heart rate grips. Do not use liquid cleaner under the running belt.

- To ensure the longevity of the running belt, clean under the running belt with a soft, dry cloth. To clean, slide the cloth between the running belt and deck from one side of the frame to the other (you may need a ruler or similar tool to slide the towel under the belt), then, holding the edges of the cloth, pull the cloth from the headroller down to the tailroller.

NOTE: DO NOT clean the running belt by activating the treadmill.

- Inspect the running belt for alignment and tension. Do not tighten the running belt every day. If you notice slipping, adjust the running belt tension using the instructions provided in “Adjustments-Slipping-Running Belt” (later in this chapter), or contact Product Support as described at the beginning of this chapter.
- Ensure the power cord is not under the treadmill and is positioned away from the elevation screws. This will prevent the power cord from being pinched or from binding up the elevation screws.

WEEKLY MAINTENANCE

- Vacuum the floor under and around the treadmill. Do so with the treadmill at its maximum elevation or moved to another spot.

NOTE: Take care not to damage the power cord while vacuuming.

- Inspect the inside surface of the running belt and the top surface of the running deck for unusual wear. Check the belt for a “glazed” condition (a smooth almost melted appearance). If the running belt appears glazed, replace the running belt and flip or replace the running deck.

NOTE: Never install a new running belt on a used deck.

- Inspect the display and handrail screws for security, and retighten if necessary.
- Inspect the display panel/keypad for wear.

BI-WEEKLY MAINTENANCE

WARNING: To prevent personal injury, always turn the treadmill off and unplug the power cord before performing maintenance inside the motor compartment.

- Remove the motor shroud and vacuum around the motor and its ventilation holes. Avoid bumping or damaging parts normally protected by the shroud.

MONTHLY MAINTENANCE

- Wipe the elevation screws down with a clean dry cloth and coat them with silicon lubricant spray to prevent rust accumulation.

ADJUSTMENTS

The running belt and its headroller, drive belt, tailroller, and running deck are designed to be self-centering, slip-free, and smooth-operating without the need for frequent adjustments. Running belt sideward movement, slipping, or grinding after extended use, or thumping during initial use, may be corrected by the following procedures:

Change Sideward Movement to TRACKING: If the running belt is not centered on the tailroller and is either too far left or right, adjust tracking using the following steps:

1. Turn the treadmill on. Increase treadmill speed to 3.0 mph (5.0 kph).
2. Adjust tracking by adjusting the tailroller Allen screws (located at the back sides of the tailroller) with a 1/4" Allen wrench in 1/4-turn increments.

If the running belt is tracking to the left, adjust the running belt to track to the right. Tighten the left tailroller Allen screw by turning clockwise, or loosen the right tailroller bolt by turning counter-clockwise.

If the running belt is tracking to the right, adjust the running belt to track to the left. Tighten the right tailroller Allen screw by turning clockwise or loosen the left tailroller bolt by turning counter-clockwise.

3. After the running belt appears to be tracking properly, increase the treadmill speed to 10.0 mph (16.0 kph) and verify that the belt stays centered.

Slipping-Running Belt: Remove the motor shroud and operate the treadmill slowly at 1 to 2 mph (2 to 3 kph). While observing the headroller, walk on the belt and try to slow it down by gently applying pressure with your feet while holding the handrails. If only the running belt, and not the headroller, slows down, tighten the running belt by turning both the right and left tailroller adjustment bolts clockwise 1/4-turn. Repeat this adjustment until the running belt no longer slips, ensuring that you turn both tailroller bolts an equal number of turns. Re-install the motor shroud. If the headroller and the running belt both slow down, tighten the drive belt as described under "Slipping-Drive Belt", below.

Slipping-Driver Belt: Adjust the treadmill incline to 5% to provide clearance underneath. Set the ON/OFF switch to the OFF position and unplug the treadmill. Remove the motor shroud. With a 1/2" socket wrench, loosen the four motor bolts. Use the socket wrench to adjust the tension bolt in the middle of the motor bracket 1/4-turn clockwise, stretching the drive belt. Tighten the motor bolts and re-install the motor shroud. Plug the treadmill in, turn it on, and test for slipping as described under "Slipping-Running Belt", above. Repeat this step as necessary.

Thumping: Turn the treadmill off. Turn the right and left tailroller adjustment bolts counter-clockwise with the 1/4" Allen wrench until the running belt is loose. Note the number of times each bolt is turned. Remove excess accumulated running deck wax from the tailroller with a credit card, a putty knife, or other flexible plastic implement. Tighten the running belt by turning the adjustment bolts clockwise the same number of turns as they were loosened. Turn the treadmill on and check for sideward movement and/or slipping of the running belt. Tighten the tailroller adjustment bolts further, if necessary, in 1/4-turn increments.

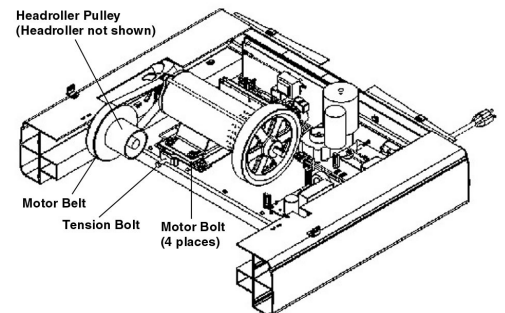
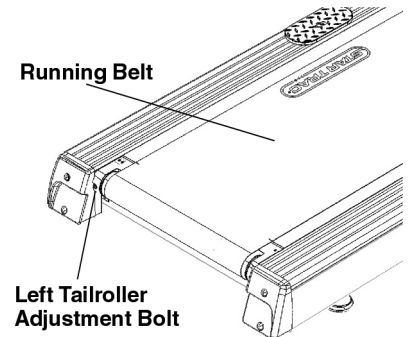

REWAX BELT

Periodic running belt rewaxing virtually eliminates belt down time, and maximizes the life of the belt. Whenever the present distance is 2000 miles (or 3000 km) more than the LAST DECK (last deck service), the start-up display will scroll REWAX BELT. This is a reminder to have your maintenance or service provider perform the 5-minute belt rewaxing procedure at your convenience. (Immediate service is not required). Wax is included in the treadmill.

TOOLS & MATERIALS

- Bottle of Wax Powder (1)
- Clean Towel (1)
- Paint Stick or Ruler (1)
- Diluted All-purpose Cleaner (409), or Bristle Brush

PROCEDURE

Apply wax powder while belt & deck are still warm (5 minutes minimum use) for optimum benefit.

1. **CAUTION: TURN TREADMILL POWER OFF AND UNPLUG THE POWER CORD BEFORE REWAXING THE BELT.**
2. **CLEAN DECK & BELT:**
 - A. Using the paint stick or ruler, slide a towel under the middle of the belt from one side of the frame to the other.

- B. Hold the edges of the towel; pull to the tailroller; pull to the headroller; then pull the belt down to wipe the remaining belt.
TIP: Fold the dirty towel and shake into trash.
3. **LIFT BELT:** Lift the left side (facing display) of the belt, about 12 inches down from the motor shroud (see figure). Hold the belt up to elevate the belt from the deck.
 4. **SPREAD WAX:** Flip the nozzle on the cap of the wax bottle. Point the nozzle at the deck. Be sure that the bottle is tilted at a downward angle. Squeeze the wax bottle *twice* between the running belt and the deck. TIP: Gently shake the bottle between each squeeze.
 5. Repeat steps 3 and 4, about 18 inches from the end of the deck.
 6. Repeat steps 3 through 5, on the right side of the belt/deck.
 7. **WALK:** Plug in the treadmill. Turn the treadmill ON/OFF switch to the ON position. Start the treadmill at 1 mph and walk on all sections of the belt and deck for 1 minute to ensure the wax has been evenly distributed and worked-in properly.
 8. **CLEANUP:** Turn the treadmill power OFF . Remove any excess wax with diluted cleaner (409) and towel. TIP: Blow away extra wax first (like dust), then wipe.
 9. **DISPLAY UPDATE:** Update the LAST DECK service mileage to remove the REWAX BELT message.
 - A. Power ON the treadmill.
 - B. Enter MAINTENANCE SETTINGS (see Chapter 8).
 - C. Press the INCLINE DOWN key until the Information Window reads LAST DECK.
 - D. Use the 0 ~ 9 keys to enter the present treadmill distance.
 - E. Press the START key to enter and update the display.
 - F. Press the STOP key to exit MAINTENANCE SETTINGS.

After having used your **STAR TRAC PRO / PRO S TREADMILL** for many workouts, you may wish to change some of its settings.

MANAGER SETTINGS

The Manager Settings allow you to query and modify the basic settings of your treadmill. To enter Manager Settings:

1. Press and *hold* the **0**, **1**, and START keys together.
2. Release the **1** key.
3. A beep will sound and “MANAGER SETTINGS” will display momentarily in the Information Window.
4. Release the remaining keys. “UNITS” will display in the Information Window.

NOTE: The system will automatically exit Manager Settings if no key is pressed for 30 seconds.

The following keys are used to modify MANAGER SETTINGS:



Incline Keys: Displays the next and previous parameter, respectively. Keys will repeat if held.



Speed Keys: Adjust the value of the displayed parameter up and down, respectively, in increments of 1 unit or 0.01 unit, as appropriate for the parameter. These keys *do not* save the new value - see **Start Key** and **Enter Key** below.



Start Key: Updates (saves) the value of the displayed parameter in Flash memory. Alternatively, the ENTER key may be used (see below).



Enter Key: Updates (saves) the value of the displayed parameter in Flash memory. Alternatively, the START key may be used (see above).

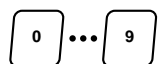

Number/Program Select Keys: Enter new data item values for numeric parameters.



Stop Key: Exits Manager Settings Mode and restarts the treadmill greeting.

The items that you may display and change with the previous keys are:

Item	Lowest Value	Default Value	Highest Value	Meaning
UNITS	-	English	-	English = units of pounds, miles, hours, minutes, seconds, feet, inches; Metric = units of kilograms, kilometers, hours, minutes, seconds, centimeters.
MINIMUM SPD*	0.5/0.8	0.5/0.8	TBD	Minimum speed in mph (UNITS=English), or km/hr (UNITS=Metric).
MAXIMUM SPD*	TBD	10.0/16.0	10.0/20.0	Maximum speed in mph (UNITS=English), or km/hr (UNITS=Metric).
ACCEL TIME	25	25	60	Time, in seconds, to reach maximum speed from 0 mph (0 km/hr).
DECEL TIME	20	20	60	Time, in seconds, to reach 0 mph (0 km/hr) from maximum speed.
ELEVATION	-	ON	-	ON=Elevation function enabled. OFF=Elevation function disabled.
TIME	5	99	99	Maximum time in minutes allowed for program, including warm-up and cool-down.
OPER HRS	0	0	65,535	Total operating hours.
DISTANCE	0	0	65,535	Total treadmill miles (UNITS=English), or km (UNITS=Metric).
WEIGHT	0	155	399/TBD	Default (to user), typical weight in lb (UNITS=English), or kg (UNITS=Metric).



Item	Lowest Value	Default Value	Highest Value	Meaning
SERIAL NO	0	0	65,535	Treadmill serial number.
LANGUAGE	-	English	-	Language in English, Dutch, French, German, Portuguese, Spanish, Swedish, Italian or Katakana.
ENTRY	-	Units	-	Speed entry: First character is UNITS, or TENTHS.
METS	-	OFF	-	ON=METS display enabled. OFF=METS display disabled.
WATTS	-	OFF	-	ON=WATTS display enabled. OFF=WATTS display disabled.
PAUSE	30	45	120	Pause duration during a program, in seconds, either 30, 45, 60, 90 or 120.
SCALE**	-	OFF	-	ON=Treadmill weight scale enabled. OFF=Treadmill weight scale disabled.
INFRA RED COM**	-	OFF	-	ON=IR communication enabled. OFF=IR communication disabled.
CSAFE**	-	OFF	-	ON=CSAFE communication enabled. OFF=CSAFE communication disabled.
FAN**	-	OFF	-	ON=Treadmill fan enabled. OFF=Treadmill fan disabled.
AUTO STOP	-	ON	-	ON=Auto stop feature enabled. OFF=Auto stop feature disabled.
ENTERTAINMENT	-	OFF	-	This feature is currently unavailable.
RAIL STOP	-	OFF	-	ON=Enables hardware stop for European units. OFF=Disables hardware stop for European units.
LOCKOUT ID	10000	12345	65535	Treadmill lockout ID.
LOCK OUT	-	OFF	-	ON=Treadmill lock out enabled. OFF=Treadmill lock out disabled.

*When the MINIMUM SPD or MAXIMUM SPD parameters are changed, the Treadmill will perform an auto calibration. To terminate the auto calibration and return the parameter to its default setting, press the STOP key.

**Available on Pro Treadmill only.

MAINTENANCE SETTINGS

Your Service Representative may need to check accumulated data about the past usage of your treadmill, test its motor and display controls, or investigate error messages. For these reasons, your treadmill is equipped with Maintenance Settings. Maintenance Settings includes all of the items available through Manager Settings, plus additional items for Service and Diagnostic use. To enter Maintenance Settings:

1. Press and *hold* the , , and START keys together.
2. Release the  key.
3. A beep will sound and “MAINTENANCE SETTINGS” will display momentarily in the Information Window.
4. Release the remaining keys. “UNITS” will display in the Information Window.

The following keys are available in MAINTENANCE SETTINGS:



Incline Keys: Displays the next and previous parameter, respectively. Keys will repeat if held.

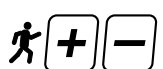

Speed Keys: Adjust the value of the displayed parameter up and down, respectively, in increments of 1 unit or 0.01 unit, as appropriate for the parameter. These keys *do not* save the new value - see **Start Key** and **Enter Key** below.



Start Key: Updates (saves) the value of the displayed parameter in Flash memory. Alternatively, the ENTER key may be used (see below).



Enter Key: Updates (saves) the value of the displayed parameter in Flash memory. Alternatively, the START key may be used (see above).



Number/Program Select Keys: Enter new data item values for numeric parameters.



Stop Key: Exits Maintenance Settings Mode and restarts the treadmill greeting.

The items that you may display and change with the previous keys are:

Item	Lowest Value	Default Value	Highest Value	Meaning
UNITS	-	English	-	English = units of pounds, miles, hours, minutes, seconds, feet, inches; Metric = units of kilograms, kilometers, hours, minutes, seconds, centimeters.
MINIMUM SPD*	0.5/0.8	0.5/0.8	TBD	Minimum speed in mph (UNITS=English), or km/hr (UNITS=Metric).
MAXIMUM SPD*	TBD	10.0/16.0	10.0/20.0	Maximum speed in mph (UNITS=English), or km/hr (UNITS=Metric).
ELEVATION	-	ON	-	ON=Elevation function enabled. OFF=Elevation function disabled.
TIME	5	99	99	Maximum time in minutes allowed for program, including warm-up and cool-down.
OPER HRS	0	0	65,535	Total operating hours.
DISTANCE	0	0	65,535	Total treadmill miles (UNITS=English), or km (UNITS=Metric).
WEIGHT	0	155	399/TBD	Default (to user), typical weight in lb (UNITS=English), or kg (UNITS=Metric).
SERIAL NO	0	0	65,535	Treadmill serial number.
LANGUAGE	-	English	-	Language in English, Dutch, French, German, Portuguese, Spanish, Swedish, Italian or Katakana.
ENTRY	-	Units	-	Speed entry: First character is UNITS, or TENTHS.
HR CONTROL	-	ON	-	ON=HR control enabled. OFF=HR control disabled.
HEART RATE	-	BOTH	-	CNT DN=manual countdown heart rate POLAR=polar receiver only CONTACT=hand contact only BOTH=polar receiver and hand contact
METS	-	OFF	-	ON=METS display enabled. OFF=METS display disabled.
WATTS	-	OFF	-	ON=WATTS display enabled. OFF=WATTS display disabled.
PAUSE SCALE**	30	45	120	Pause duration during a program, in seconds, either 30, 45, 60, 90 or 120. ON=Treadmill weight scale enabled. OFF=Treadmill weight scale disabled.
INFRA RED - COM**	-	OFF	-	ON=IR communication enabled. OFF=IR communication disabled.
CSAFE**	-	OFF	-	ON=CSAFE communication enabled. OFF=CSAFE communication disabled.
FAN**	-	OFF	-	ON=Treadmill fan enabled. OFF=Treadmill fan disabled.
AUTO STOP	-	ON	-	ON=Auto stop feature enabled. OFF=Auto stop feature disabled.

Item	Lowest Value	Default Value	Highest Value	Meaning
ENTERTAINMENT	-	OFF	-	ON=Entertainment enabled. OFF=Entertainment disabled.
RAIL STOP	-	OFF	-	ON=Enables hardware stop for European units. OFF=Disables hardware stop for European units.
10 REV	22.0	30.7	74.0	Inches of running belt travel for 10 flywheel revolutions, always measured in inches. Nominal values are: <ul style="list-style-type: none"> ■ 1.6" pulley: 27.5 ■ 1.7" pulley: 29.1 ■ 1.8" pulley: 30.7 ■ 2.1" pulley: 35.8
CNT/REV	31	31	125	Number of counts for each motor shaft revolution. Values are: <ul style="list-style-type: none"> ■ RPM sensor at flywheel notches: 31 ■ RPM sensor at motor shaft optical disk: 125
MIN PWM	2	30	55	Pulse duty cycle to obtain the selected MN SPD. Divide MN PWM by 512 to get % duty cycle.
1/2 MX	25	130	170	Pulse duty cycle to obtain 1/2 maximum speed. Divide 1/2 MX by 512 to get % duty cycle.
MAX PWM	86	230	255	Pulse duty cycle to obtain the selected MX Spd. Divide MX PWM by 512 to get % duty cycle.
ACCEL TIME	25	25	60	Time, in seconds, to reach maximum speed from 0 mph (0 km/hr).
DECEL TIME	20	20	60	Time, in seconds, to reach 0 mph (0 km/hr) from maximum speed.
DATE	1.00	1.98	12.99	Treadmill manufacture date.
NO RAIL STOP	0	0	255	Number of times Hand Rail Stop switch was down or disconnected on power-up since last reset.
KEY DOWN	0	0	255	Number of times key other than 5 or 8 was down on power-up since last reset.
SPEED CHG	0	0	255	Number of times speed changed suddenly more than 2 mph (UNITS=English) or 2 km/hr (UNITS=Metric) since last reset.
ELEV STALL	0	0	255	Number of times elevation failed to change (stalled) since last reset.
ELEV RANGE	0	0	255	Number of times elevation was out of range (not between 0% and 15%) at power-up since last reset.
ELEV LOST	0	0	255	After pressing START and reaching 0% reset, the number of times elevation went beyond 0% to 15%, since last reset.
NO MOTOR	0	0	255	Number of times the motor could not verify a load since last reset.
NO SENSOR	0	0	255	Number of time the sensor was inoperable since last reset.
ELEV ZERO	175	240	242	Representation of voltage to elevation motor to obtain 0% elevation. Multiply ELEV ZERO by 0.019608 to get actual voltage.
ELEV MAX	25	57	170	Representation of voltage to elevation motor to obtain 15% (maximum) elevation (incline). Multiply ELEV MAX by 0.019608 to get actual voltage. 120 volt treadmill = 57 230 volt treadmill = 80
LAST DECK	0	0	65,535	Number of miles (UNITS=English), or km (UNITS=Metric) since the running deck was last serviced or replaced.
LAST BELT	0	0	65,535	Number of miles (UNITS=English) or km (UNITS=Metric) since the running belt was last replaced.
LAST MOTOR	0	0	65,535	Number of miles (UNITS=English), or km (UNITS=Metric) since the motor brushes were last serviced or replaced.
MASTER PIN	0000	4321	9999	Master Personal Identification Number (PIN) for Personal Trainer.

Item	Lowest Value	Default Value	Highest Value	Meaning
LOCKOUT ID	10000	12345	65535	Treadmill lockout ID.
LOCK OUT	-	OFF	-	ON=Treadmill lock out enabled. OFF=Treadmill lock out disabled.
AUTOST	-	OFF	-	ON=Automatic reporting of CSAFE state changes enabled. OFF= ON=Automatic reporting of CSAFE state changes disabled.
MODEL	0	5	255	Model number used by CSAFE to distinguish between different models and equipment.
QUICK-START	0	0	65,535	Number of time the Quick Start program was run since last reset.
MANUAL**	0	0	65,535	Number of times the Manual program was run since last reset.
FOREST	0	0	65,535	Number of times the Forest Walk program was run since last reset.
TRAIL**	0	0	65,535	Number of times the Trail Blazer program was run since last reset.
ALPINE**	0	0	65,535	Number of times the Alpine Pass program was run since last reset.
MYSTERY**	0	0	65,535	Number of times the Mystery Hike program was run since last reset.
5K LAKE	0	0	65,535	Number of times the 5K Lake Loop program was run since last reset.
10K BAY**	0	0	65,535	Number of times the 10K Bay Run program was run since last reset.
CUSTOM**	0	0	65,535	Number of times the Custom Interval program was run since last reset.
DHRC**	0	0	65,535	Number of times the Dynamic Heart Rate Control program was run since last reset.
FIT TEST**	0	0	65,535	Number of times the Fitness Test program was run since last reset.
TRAINER**	0	0	65,535	Number of times the Personal Trainer program was run since last reset.

*When the MINIMUM SPD or MAXIMUM SPD parameters are changed, the Treadmill will perform an auto calibration. To terminate the auto calibration and return the parameter to its default setting, press the STOP key.

**Available on Pro Treadmill only.

CALIBRATE SCALE

The Calibrate Scale function allows for calibration of the treadmill's integral weight scale. This function requires a calibrated weight set. You must also know your current weight. Additionally, your current weight must be at least 150 pounds. To enter the Calibrate Scale function:

- While in the Maintenance Settings mode, press the **[2]** key, as necessary, until "CALIBRATE SCALE" is shown in the information window.
- The Information Window will display the Calibrate Scale menu: "1 = INPUT SPAN WEIGHT - 2 = CAL SPAN WEIGHT - 3 = CAL ZERO WEIGHT - 4 = VERIFY WEIGHT - PRESS STOP TO EXIT".
- You may calibrate the weight scale using either your body weight, or the calibrated weight set. When calibrating the weight scale using your body weight, you must know your current body weight.
- To calibrate the weight scale using your body weight:
 - Press the **[1]** key. The Information Window will display the message "REF WEIGHT = 155", followed by the message "STEP ON WEIGHT PADS - PRESS ENTER TO BEGIN".
 - Stand on the weight scale. If your weight is other than 155 units (pounds or kilograms, as appropriate), press the **[+]** or **[-]** key, as necessary, to increase or decrease the reference weight value in 1 pound (or 1 kg) increments until your actual weight is displayed.
 - When your correct weight has been entered, press the ENTER key and remain standing on the weight scale. The Information Window will display the message "CALIBRATING".
 - When calibration is complete, the Information Window will display the message "SPAN CAL = XXX", followed by the message "PRESS ENTER TO ACCEPT - PRESS STOP TO REJECT".

- Press the ENTER key to accept the displayed value. The Information Window will return to the Calibrate Scale menu. Proceed to step 6.
5. To calibrate the weight scale using the calibrated weight set:
 - Press the **2** key. The Information Window will display the message “PLACE CAL WEIGHT ON WEIGHT PADS”, followed by the message “PRESS ENTER TO BEGIN”.
 - Place the calibrated weights (125 lbs. per weight) on the weight scale, then press the ENTER key. The Information Window will display the message “CALIBRATING”.
 - When calibration is complete, the Information Window will display the message “WEIGHT ###”, followed by the message “ENTER TO ACCEPT -STOP TO REJECT”.
 - Press the ENTER key to accept the displayed value. The Information Window will return to the Calibrate Scale menu. Proceed to step 6.
 6. Press the **3** key. The Information Window will display the message “REMOVE WEIGHT ON WEIGHT PADS”, followed by the message “PRESS ENTER TO BEGIN”.
 7. Remove the calibrated weights from the weight scale, then press the ENTER key. The Information Window will display the message “CALIBRATING”.
 8. When calibration is complete, the Information Window will display the message “WEIGHT ###”, followed by the message “ENTER TO ACCEPT -STOP TO REJECT”.
 9. Press the ENTER key to accept the displayed value. The Information Window will return to the Calibrate Scale menu.
 10. Press the **4** key. The Information Window will display the message “WEIGHT = 0”. Stand on the weight scale and verify the Information Window displays your correct weight. Step off the weight scale.
 11. Place the calibrated weights on the weight scale and verify the Information Window displays 250 pounds, or, stand on the weight scale and verify the information window shows your correct weight.
 12. Press the STOP key to exit the Calibrate Scale function.

SPEED CALIBRATION

The Speed Calibration function allows for calibration of the treadmill's speed function. To enter the Speed Calibration function:

1. While in the Maintenance Settings mode, press the **8** key.
2. The Information Window will display the message “ABC D E”, where ABC is between “233” and “241” (representing digital elevation at zero level), D is “3” and E is “0”.
3. Press the **FOREST** key. The Information Window will display the message “CAL 3 0”. The treadmill belt will begin moving as auto-calibration starts.
4. Verify the values in the Information Window changes as the treadmill speed reaches maximum (~10 mph) and returns to zero. When calibration is complete, the Information Window will display the message “CAL 3 0”.
5. Press the STOP key to exit the Speed Calibration function.

ELEVATION CALIBRATION

The Elevation Calibration function allows for calibration of the treadmill's elevation function. To enter the Elevation Calibration function:

1. While in the Maintenance Settings mode, press the **8** key.
2. The Information Window will display the message “ABC D E”, where ABC is between “233” and “241” (representing digital elevation at zero level), D is “3” and E is “0”.
3. Press the **↓** key, as necessary, until the treadmill is at zero (0%) elevation. When minimum elevation is obtained, press and hold the **0** key until a “Z” is displayed in the Information Window next to the value in the “ABC” field; “236Z” for example.
4. Press the **ALPINE** key to accept the displayed value as elevation zero. The “Z” will be removed from the Information Window display.
5. Press the **↑** key until the treadmill is at maximum (15%) elevation. The Information Window will display the message “ABC D E”, where ABC is between “60” and “70” (representing digital elevation at maximum level), D is “3” and E is “0”.

- When maximum elevation is obtained, press and hold the **0** key until an “M” is displayed in the Information Window next to the value in the “ABC” field; “68M” for example.
- Press the **ALPINE** key to accept the displayed value as elevation maximum. The “Z” will be removed from the Information Window display.
- Press the STOP key to exit the Elevation Calibration function.

CLUB NAMING

The Club Naming function lets you store up to 10 unique names/messages that display in the Information Window when the treadmill is powered on and idle. Using the Club Naming function you may add a new club name/message, view a list of club names/messages stored in the treadmill’s memory, select a saved club name/message for display and delete a club name/message from memory. To enter the Club Naming function:

- While in the Maintenance Settings mode, press the **F**, **▲**, **▼** keys, as necessary, until “CLUB NAMING” is shown in the Information Window, then press the ENTER key.
- The Information Window displays the Club Naming menu “1 TO SELECT CLUB - 2 TO ADD CLUB - 3 TO DELETE CLUB - 4 TO VIEW CLUB”.

To add a new club name/message:

- From the Club Naming menu, press the **2** key. A blinking cursor is shown in the first character position of the Information Window.
- Press the **F**, **+**, **-** keys, as necessary, until the desired character is obtained. Press the **F**, **▲** key to move the cursor to the next character position (if necessary, use the **F**, **▼** button to return to a previous character position).
- Repeat step 2, as necessary, until the complete club name/message has been added, then press the ENTER key. The Information Window displays the message “VERIFYING CLUB NAME - CONFIRM ADD” followed by the message “PRESS ENTER TO ADD - PRESS STOP TO CANCEL”.
- Press the ENTER key to save the club name/message to the treadmill’s memory (press the STOP key to cancel the addition and return to the Club Naming menu).
- The Information Window will display the message “ADDED CLUB X OF 10” briefly, then return to the Club Naming menu.
- Repeat steps 1 through 5 to add additional club names/messages.

NOTE: If you enter a club name/message that has already been saved to memory, the Information Window will display the message “CLUB NAME EXISTS” followed by the message “PRESS ENTER TO RETRY - PRESS STOP TO CANCEL”. Press the STOP key to return to the Club Naming menu, then repeat steps 1 through 5 to enter a new club name/message.

- When all desired club names/messages have been entered, select another option from the Club Naming menu, or, press the STOP key to exit the Club Naming function.

To view saved club names/messages:

- From the Club Naming menu, press the **4** key. The Information Window will display the first saved club name/message.
- Press the **F**, **+**, **-** keys, as necessary, to scroll through the list of saved club names/messages.
- Press the STOP button to return to the Club Naming menu. Select another option from the Club Naming menu, or, press the STOP key to exit the Club Naming function.

To select a saved club name/message for display:

- From the Club Naming menu, press the **1** key. The Information Window will display the first saved club name/message.
- Press the **F**, **+**, **-** keys, as necessary, to scroll through the list of saved club names/messages until the desired club name/message is shown in the Information Window.
- Press the ENTER key to select the displayed club name/message. The Information Window will display the message “CLUB X OF 10 SELECTED” briefly, then return to the Club Naming menu.
- Select another option from the Club Naming menu, or, press the STOP key to exit the Club Naming function.

NOTE: The selected club name/messages will be displayed along with the initial start-up messages.

To delete a saved club name/message:

- From the Club Naming menu, press the **3** key. The Information Window will display the first saved club name/message.

2. Press the **⬅️➕➡️** keys, as necessary, to scroll through the list of saved club names/messages until the desired club name/message is shown in the Information Window. The Information Window will display the message “DELETE CONFIRM” followed by the message “ENTER TO DELETE - PRESS STOP TO CANCEL”.
3. Press the ENTER key to delete the displayed club name/message. The Information Window will display the message “CLUB DELETED” briefly, then return to the Club Naming menu.
4. Select another option from the Club Naming menu, or, press the STOP key to exit the Club Naming function.

CSAFE COMPANY NAMING

The CSAFE Company Naming function lets you store up to 10 unique CSAFE Company names. Using the CSAFE Company Naming function you may add a new CSAFE Company name, view a list of CSAFE Company name stored in the treadmill's memory, select a saved CSAFE Company name and delete a CSAFE Company name from memory. To enter the CSAFE Company Naming function:

1. While in the Maintenance Settings mode, press the **⬅️⬆️⬇️** keys, as necessary, until “CSAFE NAMING” is shown in the Information Window, then press the ENTER key.
2. The Information Window displays the CSAFE Naming menu “1 TO SELECT CLUB - 2 TO ADD CLUB - 3 TO DELETE CLUB - 4 TO VIEW CLUB”.

To add a new CSAFE Company Name:

1. From the CSAFE Naming menu, press the **2** key. A blinking cursor is shown in the first character position of the Information Window.
2. Press the **⬅️➕➡️** keys, as necessary, until the desired character is obtained. Press the **⬅️⬆️** key to move the cursor to the next character position (if necessary, use the **⬆️⬇️** button to return to a previous character position).
3. Repeat step 2, as necessary, until the complete CSAFE Company Name has been added, then press the ENTER key. The Information Window displays the message “VERIFYING CSAFE NAME - CONFIRM ADD” followed by the message “PRESS ENTER TO ADD - PRESS STOP TO CANCEL”.
4. Press the ENTER key to save the CSAFE Company Name to the treadmill's memory (press the STOP key to cancel the addition and return to the CSAFE Naming menu).
5. The Information Window will display the message “ADDED CSAFE X OF 10” briefly, then return to the CSAFE Naming menu.
6. Repeat steps 1 through 5 to add additional CSAFE Company Names.

NOTE: If you enter a CSAFE Company Name that has already been saved to memory, the Information Window will display the message “CSAFE NAME EXISTS” followed by the message “PRESS ENTER TO RETRY - PRESS STOP TO CANCEL”. Press the STOP key to return to the CSAFE Naming menu, then repeat steps 1 through 5 to enter a new CSAFE Company Name.

7. When all desired CSAFE Company Names have been entered, select another option from the CSAFE Naming menu, or, press the STOP key to exit the CSAFE Naming function.

To view saved CSAFE Company Names:

1. From the CSAFE Naming menu, press the **4** key. The Information Window will display the first saved CSAFE Company Name.
2. Press the **⬅️➕➡️** keys, as necessary, to scroll through the list of saved CSAFE Company Names.
3. Press the STOP button to return to the CSAFE Naming menu. Select another option from the CSAFE Naming menu, or, press the STOP key to exit the CSAFE Naming function.



To select a saved CSAFE Company Name:

1. From the CSAFE Naming menu, press the **1** key. The Information Window will display the first saved CSAFE Company Name.
2. Press the **⬅️➕➡️** keys, as necessary, to scroll through the list of saved club names/messages until the desired CSAFE Company Name is shown in the Information Window.
3. Press the ENTER key to select the displayed CSAFE Company Name. The Information Window will display the message “CLUB X OF 10 SELECTED” briefly, then return to the CSAFE Naming menu.
4. Select another option from the CSAFE Naming menu, or, press the STOP key to exit the CSAFE Naming function.

NOTE: The selected club name/messages will be displayed along with the initial start-up messages.

To delete a saved CSAFE Company Name:

1. From the CSAFE Naming menu, press the **3** key. The Information Window will display the first saved CSAFE Company Name.

2. Press the    keys, as necessary, to scroll through the list of CSAFE Company Names until the desired club name/message is shown in the Information Window. The Information Window will display the message “DELETE CONFIRM” followed by the message “ENTER TO DELETE - PRESS STOP TO CANCEL”.
3. Press the ENTER key to delete the displayed CSAFE Company Name. The Information Window will display the message “CSAFE DELETED” briefly, then return to the CSAFE Naming menu.
4. Select another option from the CSAFE Naming menu, or, press the STOP key to exit the CSAFE Naming function.

Star Trac recommends that you refer your questions about your **STAR TRAC PRO S / PRO / PRO ELITE TREADMILL** operation and suspected malfunctions to Star Trac's Service Hotline at (800) 503-1221, or USA 1-714-669-1660. However, you may wish to investigate error messages that appear in the Information Window. You may do so by reviewing the information in this section.

KEY DN: This error generally occurs when a key is held pressed while the **ON/OFF** switch is moved to **ON**. It may also happen if a key becomes stuck. When you see **KEY DN:**

Set the **ON/OFF** switch to **OFF**; wait 2 seconds.

Set the **ON/OFF** switch to **ON**. The treadmill should be operational again. Notify Star Trac if additional assistance is needed.

NO STO: This error generally occurs when the Stop Switch is not connected tightly to the circuit board of the Display Control Panel. It may also happen if the circuitry associated with the switch develops a fault. When you see **NO STO:**

Set the **ON/OFF** switch to **OFF**; wait 2 seconds.

Set the **ON/OFF** switch to **ON**. Notify Star Trac if additional assistance is needed.

NO RPM and SP CHG: These errors generally occur when the running belt speed sensor is disconnected, faulty, or misaligned relative to the revolutions-per-minute (RPM) sensor of the motor. They may also occur if the speed sensor cable is damaged, or if the Motor Control Board (MCB) is misadjusted or faulty. When you see **NO RPM** or **SP CHG:**

Set the **ON/OFF** switch to **OFF**; wait 2 seconds.

Set the **ON/OFF** switch to **ON**. Notify Star Trac if additional assistance is needed.

EL STL, EL RN and, ELLOST: These errors generally occur when the elevation (incline) potentiometer is faulty or out of limits, or the elevation motor is disconnected or receiving low power. They may also occur if the Motor Control Board (MCB) is faulty or the motor gears are stripped. They are usually accompanied by failure of the treadmill to rise from an elevation other than maximum (or descend from an elevation other than minimum), with attendant beep indication.

FCC AND OTHER DOMESTIC / INTERNATIONAL REGULATIONS

The **PRO S / PRO / PRO ELITE** TREADMILLS have been tested and found to comply with the limits for a Class A digital device, pursuant to Part 15 of FCC rules. Under the FCC guidelines, operation is subject to the following two guidelines: (1) this device may not cause harmful interference, and (2) this device must accept any interference received, including interference that may cause undesired operation.

The Star Trac **PRO S / PRO / PRO ELITE** Treadmills generate and use radio frequency energy. If the products are not installed and used in accordance with the instructions provided in the owner's manual, interference with radio communications may occur. Likewise, if unapproved accessories are installed, interference with radio communications may occur. The intent of the FCC Class A limit is to provide reasonable protection against harmful interference in a residential installation. However, there is no guarantee that interference may not occur in a specific installation. In the event that interference is experienced, turn off the unit to verify that it is in fact the source. If the interference clears with the unit off, then try each of the following measures and combinations thereof:

- Reorient or relocate **the treadmill**.
- Reorient or relocate the receiving antenna of your television, radio, and / or VCR recorder.
- Connect the unit to a different power outlet.
- Consult Star Trac Product Support, your authorized dealer, or a qualified radio / television technician for assistance.

This product has been tested to meet the following standards:

- UL 1647 (Safety for Motor operated Message and Exercise Machines).
- CAN/CSA – E335-1/3E -94- Safety of household and Similar appliance

INTERNATIONAL REGULATIONS

This product conforms to the requirements of the European Council directives:

- 89/336/ECC, Electromagnetic Compatibility
- 92/590/EEC, General Product Safety Directives
- 73/23/EEC, Electrical equipment Low Voltage Safety Directive

Under the Directive and in addition to Domestic standards, the product also has been tested to meet the following international standards:

EN 60355-1	Safety of the household and Similar Electrical appliance
EN957-1	Safety of Machinery
EN55022	Conducted and Radiated Emission Class A
EN55014-1	Disturbance power
EN55014-2	Immunity
EN60947-5-1	Positive opening mechanism :VDE approval (pending)
EN61000-3-2	Harmonics Current Emission
EN61000-3-3	Flicker and Voltage Fluctuation
EN61000-4-3	Radiated Immunity/ Conducted Immunity
EN61000-4-2	ESD
EN61000-4-4	EFT
EN61000-4-5	Surge
EN61000-4-11	Voltage Dip & Interruption



STAR TRAC
14410 Myford Road
Irvine, California 92606
Telephone: (800) 228-6635, (714) 669-1660
Fax: (714) 508-3303
<http://www.startrac.com>